

# Compact Inlet Filters

**F Series 1/2" - 6", DN80 - DN150**

## Features

- Fully drawn weatherhood
- Low entry velocity air gap between base and cover
- Heavy gauge base with low pressure drop outlet pipe and center bracket design
- Corrosive resistant gray powder coat carbon steel

## Technical Specifications

- Temp (continuous): min -26°C (-15°F) max 104°C (220°F)
- Filter change out differential: 37-50 mbar over initial  $\Delta P$
- Pressure drop graphs available upon request
- Polyester: 99%+ removal efficiency standard to 5 micron
- Paper: 99%+ removal efficiency standard to 2 micron

## Options



- Tap holes available
- Pressure drop indicator
- Various media for different environments
- Stainless steel construction
- Various nonstandard finishes and connection styles



**Threaded Outlet Assembly**



**Flange Outlet Assembly**

Rev: F.5-6-EU1907K

# F Series 1/2" - 6", DN80 - DN150

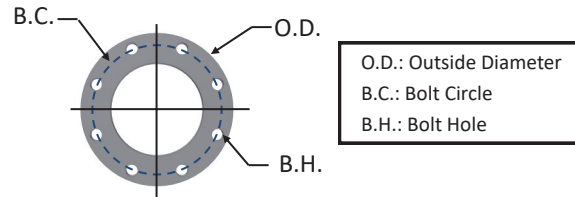
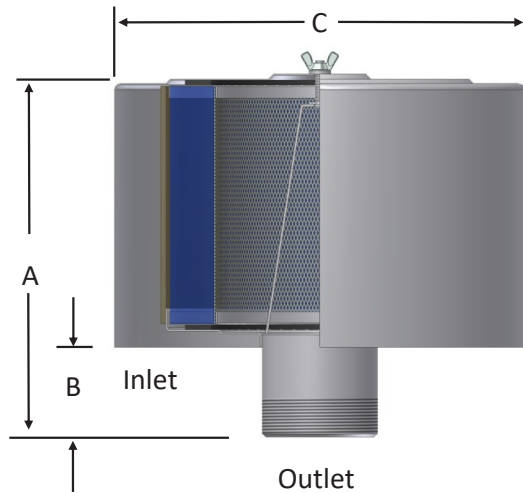

PN10 Pattern Flange	Dimensions - mm			No. of Holes	Flange Thickness mm
	O.D.	B.C.	B.H.		
DN80	200	160	18	8	20
DN100	220	180	18	8	20
DN125	250	210	18	8	22
DN150	285	240	22	8	22

Outlet Size	Outlet Type	Assembly m <sup>3</sup> /hr Rating	Assembly Part Number		Dimensions - mm			Suggested Service Ht. mm	Approx. Weight kg	Replacement Element Part No.		Element m <sup>3</sup> /hr Rating
			Polyester	Paper	A	B	C			Polyester	Paper	
1/2"	MPT	17	F-15-050	F-14-050	87	23	155	59	0.68	15	14	60
3/4"	MPT	43	F-15-075	F-14-075	96	31	155	59	0.77	15	14	60
1"	MPT	60	F-15-100	F-14-100	96	31	155	59	0.86	15	14	60
1"	MPT	94	F-19P-100	F-18P-100	165	31	155	121	1.4	19P	18P	170
1 1/4"	BSPT	119	F-19P-126	F-18P-126	178	44	155	121	1.4	19P	18P	170
1 1/2"	BSPT	145	F-19P-151	F-18P-151	179	44	155	121	1.4	19P	18P	170
2"	BSPT	230	F-31P-201	F-30P-201	186	57	200	121	2	31P	30P	332
2"	BSPT	230	F-231P-201	F-230P-201	304	57	260	241	5	231P	230P	510
2 1/2"	BSPT	332	F-31P-251	F-30P-251	205	76	200	121	2	31P	30P	332
2 1/2"	BSPT	332	F-231P-251	F-230P-251	318	64	260	241	6	231P	230P	510
3"	BSPT	510	F-231P-301	F-230P-301	323	76	260	241	6	231P	230P	510
3"	BSPT	510	F-235P-301	F-234P-301	325	76	260	244	7	235P	234P	970
3"	BSPT	510	F-275P-301	F-274P-301	338	76	457	244	11	275P	274P	1870
4"	BSPT	885	F-235P-401	F-234P-401	348	102	260	244	7	235P	234P	970
4"	BSPT	884	F-245P-401	F-244P-401	365	102	305	244	10	245P	244P	1496
4"	BSPT	885	F-275P-401	F-274P-401	359	102	406	244	12	275P	274P	1870
5"	BSPT	1360	F-245P-501	F-244P-501	351	102	305	244	10	245P	244P	1500
5"	BSPT	1360	F-275P-501	F-274P-501	356	102	406	244	12	275P	274P	1870
6"	BSPT	1870	F-275P-601	F-274P-601	384	127	406	244	13	275P	274P	1870

Note: MPT threaded housings are interchangeable with BSPT up to 1".

Flange Outlet	Assembly m <sup>3</sup> /hr Rating	Assembly Part Number		Dimensions - mm			Suggested Service Ht. mm	Approx. Weight kg	Replacement Element Part No.		Element m <sup>3</sup> /hr Rating
		Polyester	Paper	A	B	C			Polyester	Paper	
DN80	510	F-245P-DN80	F-244P-DN80	330	406	305	244	10	245P	244P	1496
DN80	510	F-275P-DN80	F-274P-DN80	330	76	406	244	10	275P	274P	1870
DN100	885	F-235P-DN100	F-234P-DN100	348	102	260	244	9	235P	234P	970
DN100	885	F-275P-DN100	F-274P-DN100	359	102	406	244	14	275P	274P	1870
DN125	1360	F-245P-DN125	F-244P-DN125	351	102	305	244	12	245P	244P	1500
DN125	1360	F-275P-DN125	F-274P-DN125	353	102	406	244	14	275P	274P	1870
DN150	1870	F-275P-DN150	F-274P-DN150	384	127	556	244	15	275P	274P	1870

See Filter Assembly Technical Data for sizing guidelines.



**SOLBERG**

[www.solbergmfg.com](http://www.solbergmfg.com)

All model offerings and design parameters are subject to change without prior notice. Contact your representative or Solberg for the most current information.

# Big Boy Inlet Filters

## F Series DN200 - DN400

### Features

- Heavy gauge base with low pressure drop outlet pipe and center bracket design
- Low entry velocity air gap between base and cover
- Corrosive resistant gray powder coat carbon steel

### Technical Specifications

- Temp (continuous): min -26°C (-15°F) max 104°C (220°F)
- Filter change out differential: 37-50 mbar over initial  $\Delta P$
- Pressure drop graphs available upon request
- Polyester: 99%+ removal efficiency standard to 5 micron
- Paper: 99%+ removal efficiency standard to 2 micron

### Options



- Tap holes available
- Pressure drop indicator
- Various media for different environments
- Stainless steel construction
- Various nonstandard finishes and connection styles

### Sumo Class Features

- Single barrel filter design allows for large airflows in space restricted work areas
- 16" to 24" flange connections available
- Designed for airflows up to 13592 m<sup>3</sup>/hr

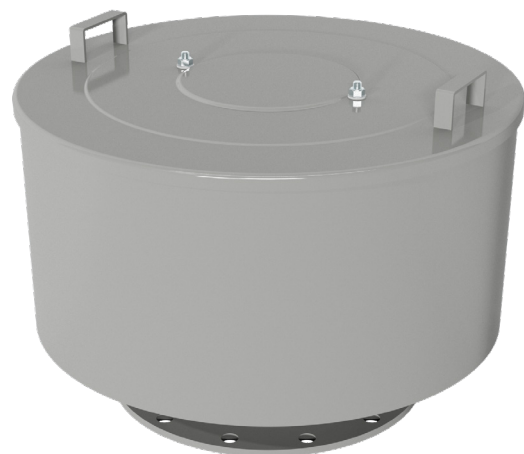

Rev: F-DN200-EU1907K

# F Series DN200 - DN400

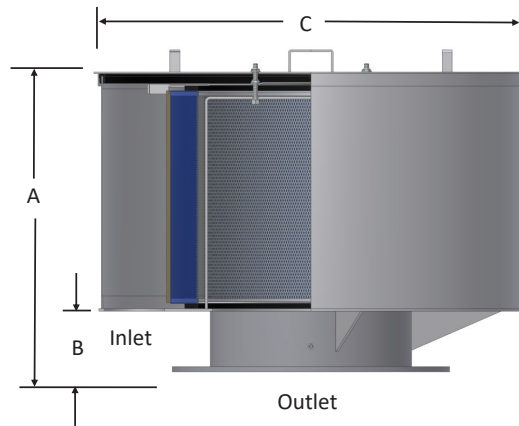

Flange Outlet	Assembly m <sup>3</sup> /hr Rating	Assembly Part Number		Dimensions - mm			Suggested Service Ht. mm	Approx. Weight (kg)	Replacement Element Part No.		Element m <sup>3</sup> /hr Rating
		Polyester	Paper	A	B	C			Polyester	Paper	
DN200	3060	F-377P-DN200	F-376P-DN200	581	152	556	368	31	377P	376P	3105
DN200	3060	F-385P-DN200	F-384P-DN200	584	152	719	368	56	385P	384P	5605
DN250	5610	F-385P-DN250	F-384P-DN250	581	152	719	368	59	385P	384P	5610
DN250	5610	F-485P-DN250	F-484P-DN250	757	152	719	546	64	485P	484P	8000
DN300	7990	F-485P-DN300	F-484P-DN300	760	152	719	546	70	485P	484P	8000
DN300	7990	F-685P-DN300	F-384P(2)-DN300	977	152	719	724	79	685P	384P(2)	11220

Flange Outlet	Assembly m <sup>3</sup> /hr Rating	Assembly Part Number		Dimensions - mm			Suggested Service Ht. mm	Replacement Element Part No.	
		Polyester	Paper	A	B	C		Polyester	Paper
DN350	9345	F-391-DN350	F-390-DN350	1038	152	1092	368	391	390
DN400	13592	F-491-DN400	F-490-DN400	809	152	1092	546	491	490

PN10 Pattern Flange	Dimensions - mm			No. of Holes	Flange Thickness mm
	O.D.	B.C.	B.H.		
DN200	340	295	22	8	24
DN250	395	350	22	12	26
DN300	445	400	22	12	26
DN350	505	460	22	16	28
DN400	565	515	26	16	32

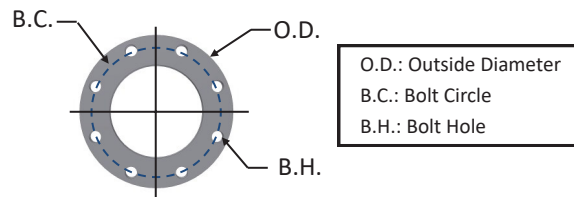

See Filter Assembly Technical Data for sizing guidelines.



**SOLBERG®**

[www.solbergmfg.com](http://www.solbergmfg.com)

All model offerings and design parameters are subject to change without prior notice.  
Contact your representative or Solberg for the most current information.

# Technical Data

## Inlet Filter Assemblies

### Applications & Equipment

- Industrial & Severe Duty
- Blowers - Side Channel & Roots (P.D.)
- Breathers
- Fuel Cells
- Piston Compressors
- Screw Compressors
- Centrifugal Compressors
- Hydraulic Breathers – fine filtration
- Engines
- Fans
- Vacuum Pumps & Systems
- Construction\Contractor Industry
- Medical
- Pneumatic Conveying
- Waste Water Aeration
- Sparging
- Factory Air
- Vacuum Vent Breathers
- Cement Processing
- Power Plants
- Centralized Air Intakes

### Identification

Standard Solberg assemblies should have an identification label/nameplate that gives the following information:

- Assembly Model #
- Replacement Element #

The part number designates the filter type, the element configuration and housing connection size. For example, the following part number identifies the filter as being an “F” design filter with a “385” element, “P” prefilter and DN250 flange connection size.

#### **F-385P-DN250**

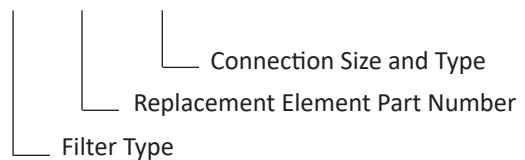

### Typical Flow Curve

See chart for the typical flow curve for inlet filtration housing comparing the percentage of rated flow with typical pressure drop.

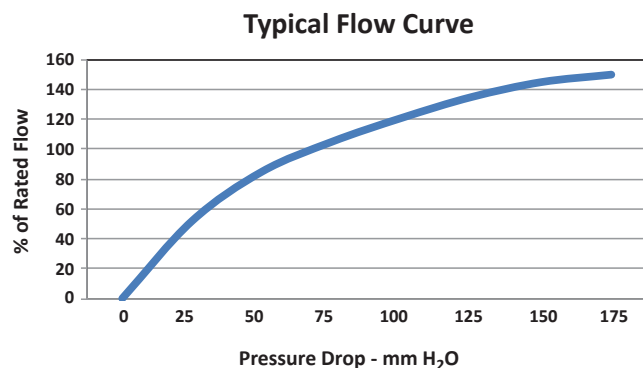

Rev: InletFTech-EU0719K

# Inlet Filter Assemblies

## Choosing the Best Filter for Your Equipment

A. When the connection & airflow is known:

1. select the appropriate connection style. (i.e.: BSPT, Flange, BSPP, etc.)
2. check assembly m<sup>3</sup>/hr (flow) rating. Compare with your required airflow.

(Note: Assembly flow ratings are based on 6,000 FPM or 30m/sec for a given connection size to achieve low pressure drop performance. When required flow exceeds assembly flow rating, the pressure drop through the outlet connection will increase. In such cases select by element m<sup>3</sup>/hr (flow) rating.)

3. when required flow rating matches connection size; skip to "C. Selecting Elements".

B. When the connection size is unknown, flexible, or the required flow rating exceeds assembly flow rating:

1. match required flow rating with the element flow rating.
2. choose related connection size.

C. Selecting Elements: The filter performance is influenced by the actual application duty and the equipment it is installed on. Regular maintenance checks and proper servicing is required.

### **Application Duty Descriptions:**

Industrial Duty: clean workshop or clean outdoor environment - small element sizing is sufficient.

Severe Duty: dirty workshop, wastewater – medium to large element is recommended.

Extreme Duty: cement, steel making, plastics or dusty material conveying – largest element sizing is recommended.

1. Select media required by your application. Options include:

a. Standard media

1. Polyester: all purpose; withstands pulses, moisture, and oily air
2. Paper: mostly dry, smooth flow applications

b. Special media: for a variety of micron levels and media types, see the "Filter Media Specifications" in the Replacement Element Section or contact Solberg.

2. Select element size by matching the element with the anticipated duty and upsize accordingly.

## Filter Assembly Maintenance

Request the appropriate maintenance manual for more in-depth information from your Solberg representative or on our website [www.solbergmfg.com](http://www.solbergmfg.com).

## Element Maintenance

Solberg elements should be replaced once the pressure drop reaches 37-50 mbar above the initial pressure drop of the installation. Cleaning the element is also an option.

Solberg recommends replacing dirty elements for optimal performance. Any damage which results from by-pass or additional pressure drop created by element cleaning is the sole responsibility of the operator.

Note: The overall performance of a filter element is altered once cleaned. The initial pressure drop after subsequent cleanings will be greater than the original, clean pressure drop of the element. After each cleaning, the pressure drop will continue to increase. Under all circumstances, the initial pressure drop of the element needs to be maintained at less than 37 mbar.

If the pressure drop exceeds 50 mbar at start-up, it should be replaced with a new element. With many types of equipment, the maximum pressure drop allowed will be dictated by the ability of the equipment to perform to its rated capacity. Under all circumstances, the operator should avoid exceeding the manufacturer's recommended maximum pressure drop for their specific equipment.



# SOLBERG

[www.solbergmfg.com](http://www.solbergmfg.com)

All model offerings and design parameters are subject to change without prior notice.  
Contact your representative or Solberg for the most current information.