

General information

PVS920200513

The CS20 S-type (tension and compression) load cell has been designed for the industrial fiscal weighing of small tanks and hoppers, it has excellent characteristics of linearity and precision and an excellent resistance to overloads of more than 300%. The CS20 cell is made of nickel-plated steel, it is weather-proof for use in severe environmental conditions and it is available in a special version for high temperature.



Suggested related products

A highly performing weighing system must be accurate, perfectly calibrated and well maintained. In order to improve the load cell performance and to optimize its functioning, you may need the following products:

Weight Transmitter [DAT 1400](#)

Weight Indicator [MCT 1302](#)

Tester 1008 [TESTER 1008](#)

Junction Box [CGS4-C](#)

Universal load cell [CS30](#)

S-Type load cell [TRZ](#)

All indicated data may be changed without notice.
All the measures indicated are expressed in millimeters (mm).

Technical specifications

PVS920200513

Rated load RL:	25, 50, 100, 150, 200, 250, 300, 500, 600, 750, 1000, 1500, 2000, 2500, 3000, 5000, 7500, 10000, 15000, 20000, 30000 Kg
Combined error:	< ±0.02 % RL
Repeatability:	< ±0.01 % RL
Creep (30 minutes):	±0.02 % RL
Safe overload:	150 % RL
Ultimate overload:	300 % RL
Material:	Nickel steel
Degree of protection:	IP67
Accuracy class:	3000 OIML (100 ÷ 2500 kg)
Deflection:	0.2 ÷ 0.4 mm
Compensated Temperature:	-10 ÷ +40 °C
Temperature range:	-35 ÷ +65 °C
Temperature effect on zero balance:	< ±0.01 % RL/5°K
Temperature effect on output:	< ±0.006 % RL/5°K
Rated output RO:	2 mV/V ±0.004 %
Zero balance:	< ±1.5 % RL
Insulation resistance:	> 5000 MOhm
Input resistance:	350 ±3.5 Ohm
Output resistance:	351 ±2.0 Ohm
Recommended input:	5 ÷ 12 Vdc/ac
ATEX certified version:	II1G Ex ia II1C T4; II1D Ex iaD20T73°C; II3G nL ia II C T4

All indicated data may be changed without notice.
 All the measures indicated are expressed in millimeters (mm).

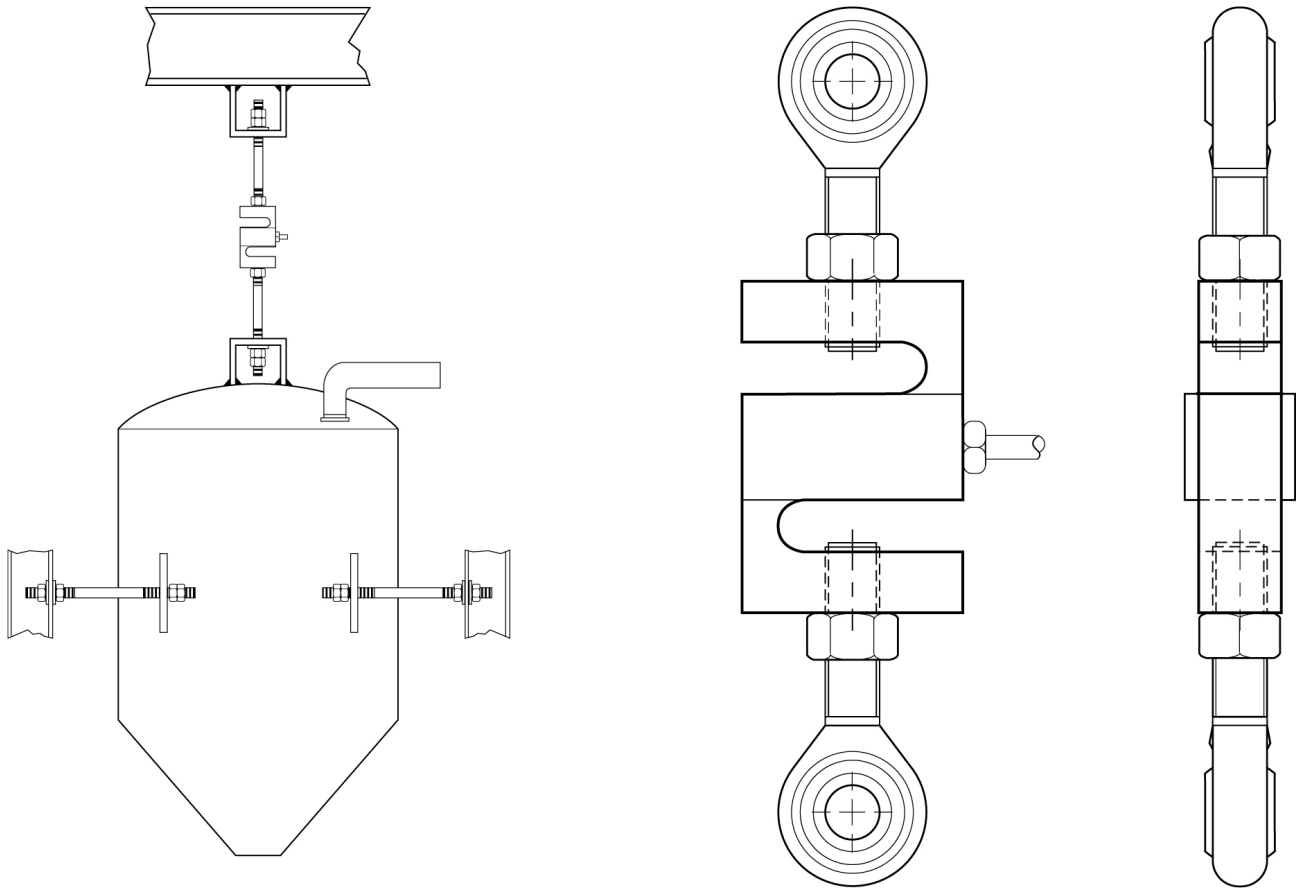
Electrical connection

+Excitation	Red
-Excitation	Black
+Signal	Green
-Signal	White
Shield	Cable shield

All indicated data may be changed without notice.
 All the measures indicated are expressed in millimeters (mm).

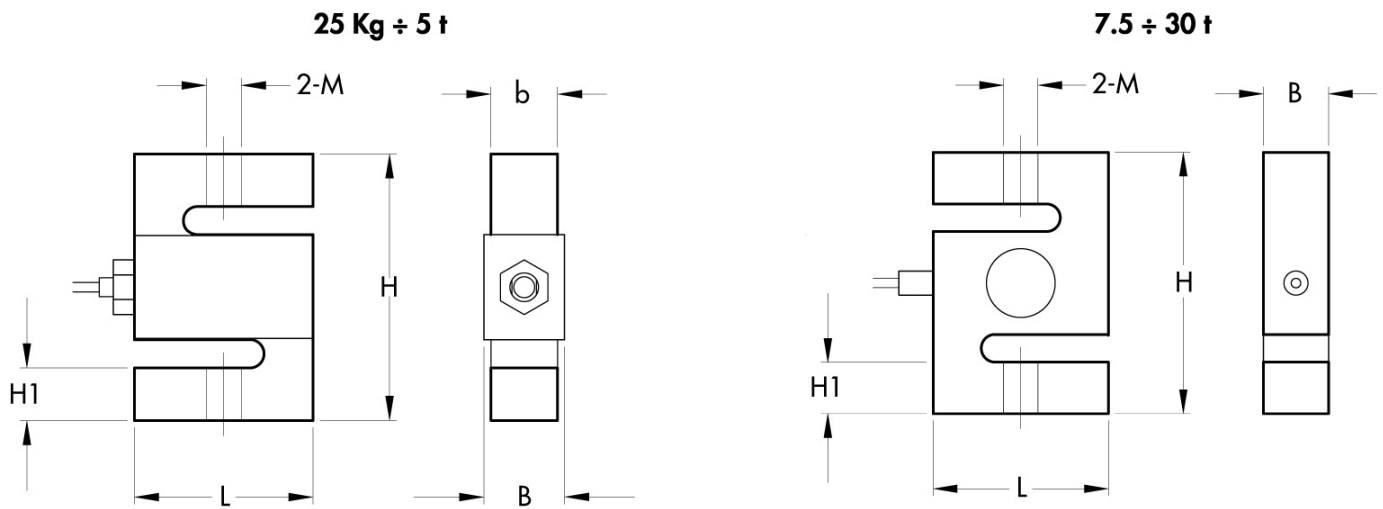

MODEL	L	H	b	B	M	H1
25-50 kg	50.8	76.2	12.7	14.5	M8	15.7
100-150 kg	50.8	76.2	19.0	20.8	M10x1.5	15.3
200-750 kg	50.8	76.2	19.0	20.8	M12x1.75	13.6
1-1.5 t	50.8	76.2	25.4	27.2	M12x1.75	12.1
2-5 t	76.2	101.6	25.4	27.2	M20x1.5	20.0
7.5-10 t	125	175	/	50	M33x3	40.2
15-20 t	160	200	/	60	M42x3	51.0
30 t	190	230	/	80	M42x3	57.5

All indicated data may be changed without notice.
 All the measures indicated are expressed in millimeters (mm).