

General information

PVS27420200513

DE MOUNTING KIT, unique in its kind, represents an excellent solution for complex situations where precision and strength are required. It is ideal for weighing roller conveyors, platforms, hoppers and tanks and it is able to absorb thermal expansion, deformation and structural failure. DE MOUNTING KIT is an accessory that allows easy replacement of the cell during maintenance by using the 4 bolts installed on the top plate as a jack. Anti-tilting function is included. Stainless steel AISI 304 and stainless steel AISI 316 versions are available upon request. When used with DDR load cells with a capacity of 3 ÷ 20 t, 30 ÷ 50 t and 75 ÷ 100 t, the DE MOUNTING KIT has to be in stainless steel or alloy steel.

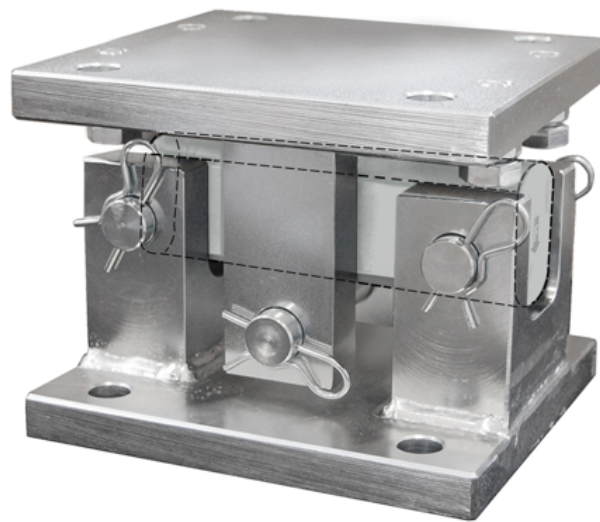

Suggested related products

A highly performing weighing system must be accurate, perfectly calibrated and well maintained. In order to improve the load cell performance and to optimize its functioning, you may need the following products:

Mounting kits [MKX](#)®

Tester 1008 [TESTER 1008](#)

Shear beam load cells [65023](#)

Junction Box [CGS4-C](#)

Double Shear Beam Load Cell [DDR](#)

Shear beam load cells [SBR](#)

All indicated data may be changed without notice.
All the measures indicated are expressed in millimeters (mm).

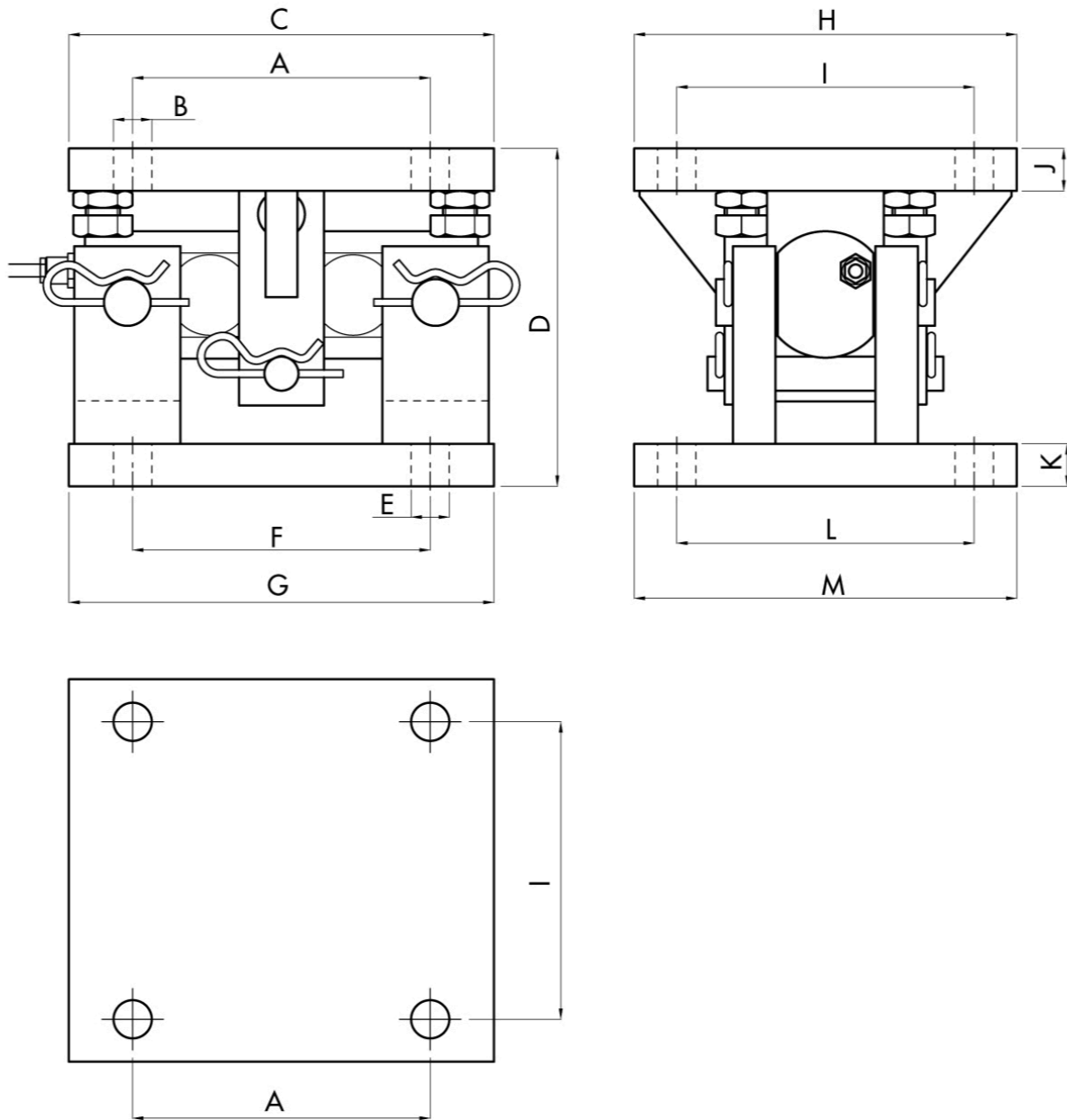
Mounting kits DE MOUNTING KIT

MODEL	CAPACITY	A	ØB	C	D	ØE	F	G	H	I	J	K	L	M	WEIGHT
DE1 AS/SS	3-20t	140	18	200	160	18	140	200	180	140	20	20	140	180	17kg
DE2 AS/SS	30-50t	175	22	300	200	22	175	300	220	175	25	25	175	220	39kg
DE3 AS/SS	75-100t	220	26	370	270	26	220	370	300	220	30	30	220	300	82kg

All indicated data may be changed without notice.
 All the measures indicated are expressed in millimeters (mm).

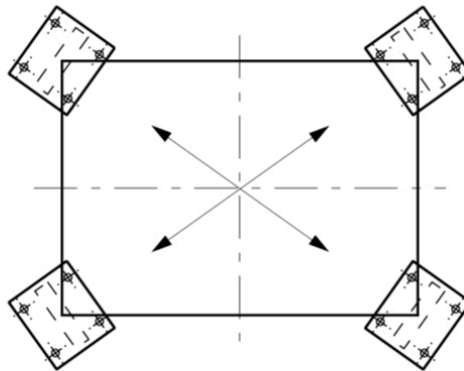
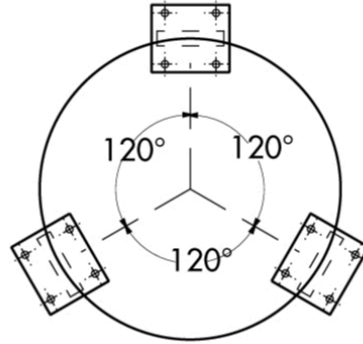

	3-20t	30-50t	75-100t	3-20t S.Steel	30-50t S.Steel	75-100t S.Steel
MAX. PERMISSIBLE SIDE LOAD OFFSET TRANSVERSE TO LOAD CELL	±5mm	±5mm	±10mm	±5mm	±5mm	±10mm
MAX. PERMISSIBLE LIFTING FORCE	6.4T	10.3T	21.1T	8T	13T	21.8T
MAX. PERMISSIBLE FORCE TRANSVERSE TO LOAD CELL	4.2T	7T	9.7T	3.6T	5.4T	7.4T
MAX. PERMISSIBLE FORCE LONGITUDINAL TO LOAD CELL	9.4T	14.6T	15.4T	7.2T	14.4T	18.4T

All indicated data may be changed without notice.
 All the measures indicated are expressed in millimeters (mm).