

General information

PVS720200513

The tension load cell 60001 has been designed for the industrial weighing of small tanks and hoppers. The S-type load cell 60001 has excellent linearity and accuracy features and excellent overload resistance of over 300%. Made of nickel-plated steel, the traction load cell 60001 has a watertight protection for use in severe environmental conditions.



Suggested related products

A highly performing weighing system must be accurate, perfectly calibrated and well maintained. In order to improve the load cell performance and to optimize its functioning, you may need the following products:

Weight Transmitter [UWT 6008](#)

Weight Transmitter [DAT 1400](#)

Tester 1008 [TESTER 1008](#)

Junction Box [CGS4-C](#)

Universal load cell [CS20](#)

Universal load cell [CS30](#)

All indicated data may be changed without notice.
All the measures indicated are expressed in millimeters (mm).

Technical specifications

PVS720200513

Rated load RL:	50, 100, 250, 500, 1000, 2500, 5000, 10000 Kg
Combined error:	< ± 0.02 % RL
Repeatability:	< ± 0.01 % RL
Creep (30 minutes):	± 0.017 % RL
Safe overload:	150 % RL
Ultimate overload:	300 % RL
Material:	Nickel steel
Degree of protection:	IP67
Accuracy class:	3000 OIML (250 ÷ 2500 kg)
Deflection:	0.3 ÷ 0.6 mm
Compensated Temperature:	-10 ÷ +40°C
Temperature range:	-18 ÷ +65°C
Temperature effect on zero balance:	< ± 0.0010 % RO/°F
Temperature effect on output:	< ± 0.0007 % output/°F
Rated output RO:	3 mV/V ± 0.25 %
Zero balance:	± 1 % RO
Insulation resistance:	> 1000 MOhm
Input resistance:	343 ÷ 450 Ohm
Output resistance:	349 ÷ 355 Ohm
Recommended input:	5 ÷ 15 Vdc/ac

All indicated data may be changed without notice.
All the measures indicated are expressed in millimeters (mm).

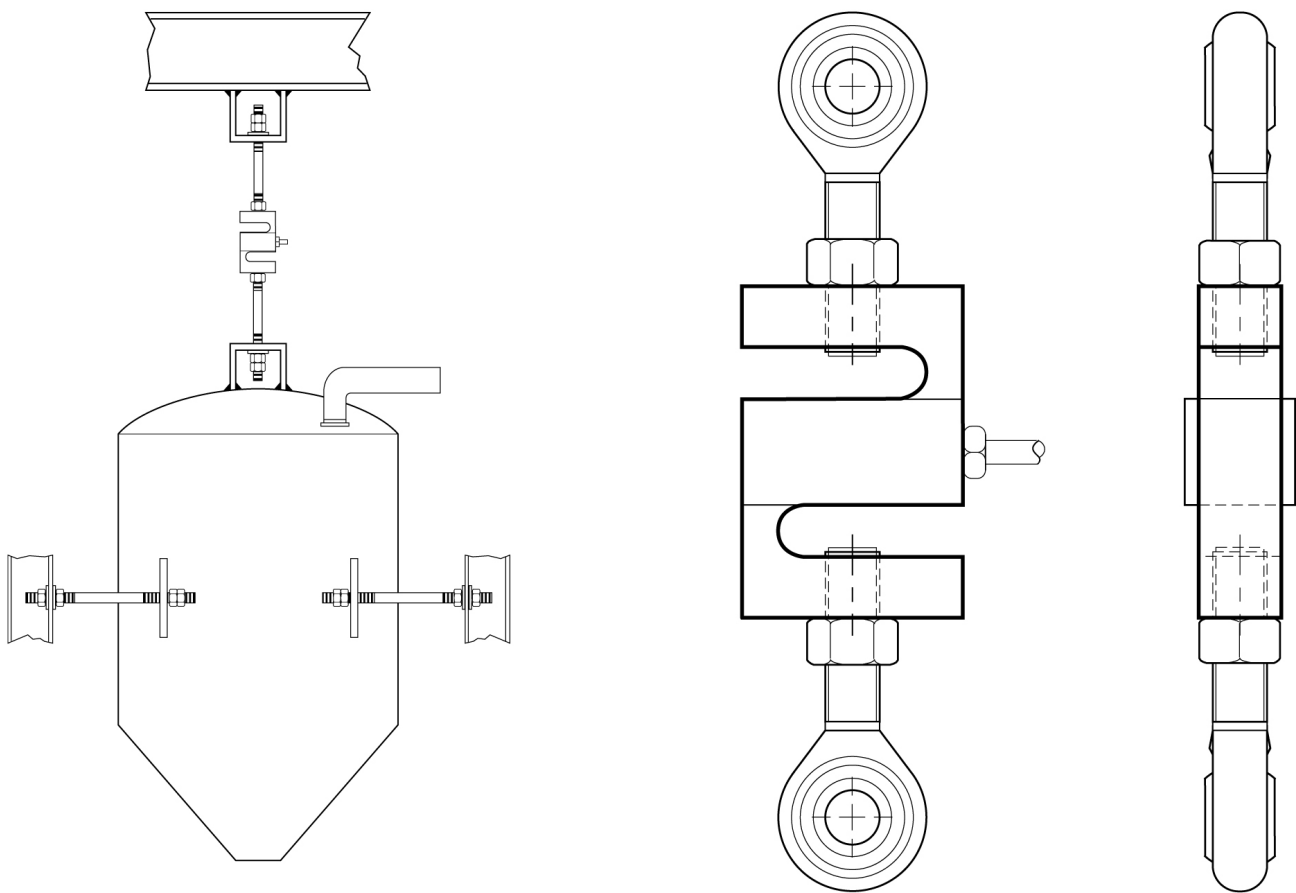

All indicated data may be changed without notice.
 All the measures indicated are expressed in millimeters (mm).

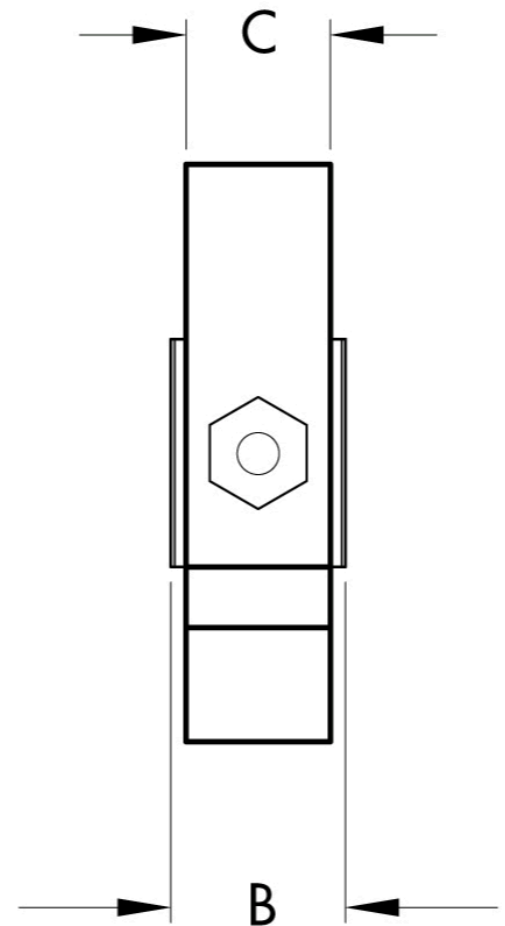
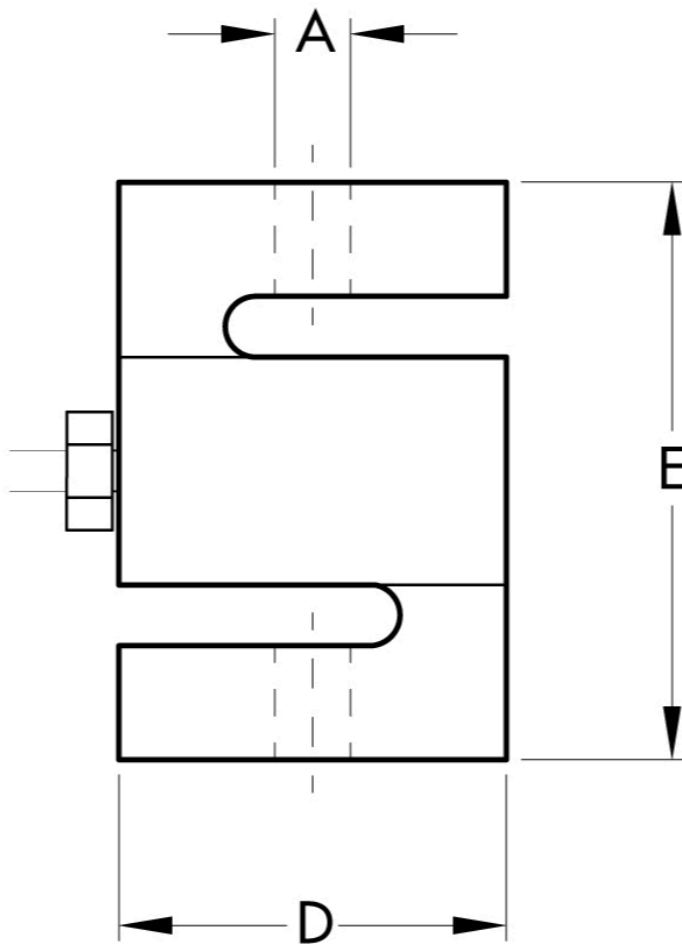
Electrical Connection

+Excitation	Red
-Excitation	Black
+Signal	Green
-Signal	White
Shield	Cable shield

CAPACITY	A	B	C	D	E
50-100 kg	M8x1.25-6H	16.5	12.7	50.8	63.5
250-1 t	M12x1.75-6H	25.4	19.1	50.8	76
2.5 t	M20x1.5-6H	31.8	25.4	76.2	108
5 t	M20x1.5-6H	31.8	25.4	88.9	120.7
10 t	M20x2.0-6H	57.2	50.8	127.0	177.8

All indicated data may be changed without notice.
 All the measures indicated are expressed in millimeters (mm).