

## Product Overview

The Atlas Valve, Series 52334, is an air suspension control platform capable of delivering customized ride control solutions to meet today's varied demands. With actuation of an additional pilot signal, operator can raise or lower suspension to a predetermined secondary height. Alternative secondary functions such as air retention (blocking mode) and variable air flow (anti-jacking) can be incorporated with an auxiliary air pilot signal as well. Through second-ride height and air retention functions, Atlas enables end-users to drop and hook freight efficiently and reduce maintenance cost significantly in vocational applications. As a Shear-Seal® patented technology, Atlas provides the same high performance and reliability as the 52341 Dump Valve Series, designed to take on the most adverse and demanding road conditions.

## Four Distinct Modes Available:

- ▶ Raised Suspension
- ▶ Lowered Suspension
- ▶ Blocking Mode (Shut-Off)
- ▶ Variable Air Flow (High/Low)

## Applications

- ▶ Truck
- ▶ Tractor
- ▶ Trailer
- ▶ Bus
- ▶ RV
- ▶ Coach

## Features

- ▶ Customizable second ride height
- ▶ Shear-Seal® Technology provides superior performance and durability
- ▶ High flow integral dump for simplified installation
- ▶ Proportional flow reduces vehicle air consumption
- ▶ Precise dead band optimizes ride height control
- ▶ Dual outlet ports with bag cross talk control limits side to side interaction which improves cornering performance
- ▶ Optional push-to-connect fittings ease installation
- ▶ Compact size and customizable design fits any application

## Atlas Valve Flow Curve

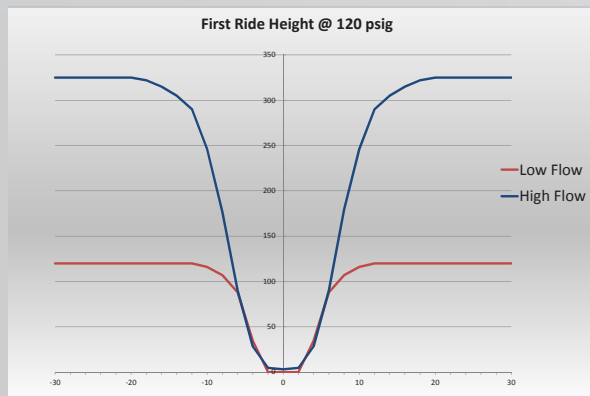

## General Specifications

<b>Operating Media</b>	Air
<b>Seal Type</b>	Shear-Seal®
<b>Operating Pressure</b>	130 psi (9 bar) Maximum
<b>Operating Temperature</b>	-40°F to +150°F (-40°C to +65°C)
<b>Flow Curve</b>	Proportional response
<b>Maximum Flow Rate (@ 120 psi)</b>	Low flow: 120 L/Min (4.2 cfm) Standard flow: 325 L/Min (14.2 cfm)
<b>Port size</b>	Standard 1/4" NPT, PTC
<b>Delivery Ports (Bag Ports)</b>	Dual delivery ports
<b>Mounting Studs</b>	1/4-20 UNC, M6
<b>Maximum Handle Movement</b>	+/- 75° for fill or exhaust
<b>Dump Flow Rate</b>	875 L/min (31 cfm)
<b>Port Activation</b>	Dump: 70 psi (4.8 bar) minimum Auxiliary: 70 psi (4.8 bar) minimum
<b>Port Configuration</b>	Dump: Normally open or normally closed Auxiliary: Normally open or normally closed
<b>Materials Of Construction</b>	<b>Body:</b> Anodized aluminum <b>Housing:</b> Engineered plastics <b>Lever:</b> Zinc plated steel <b>Internal Elements:</b> Stainless steel <b>Seals:</b> Buna-N
<b>Weight (typical)</b>	1.6 lb (726g)

## Atlas Valve Configurations & Mounting Orientation

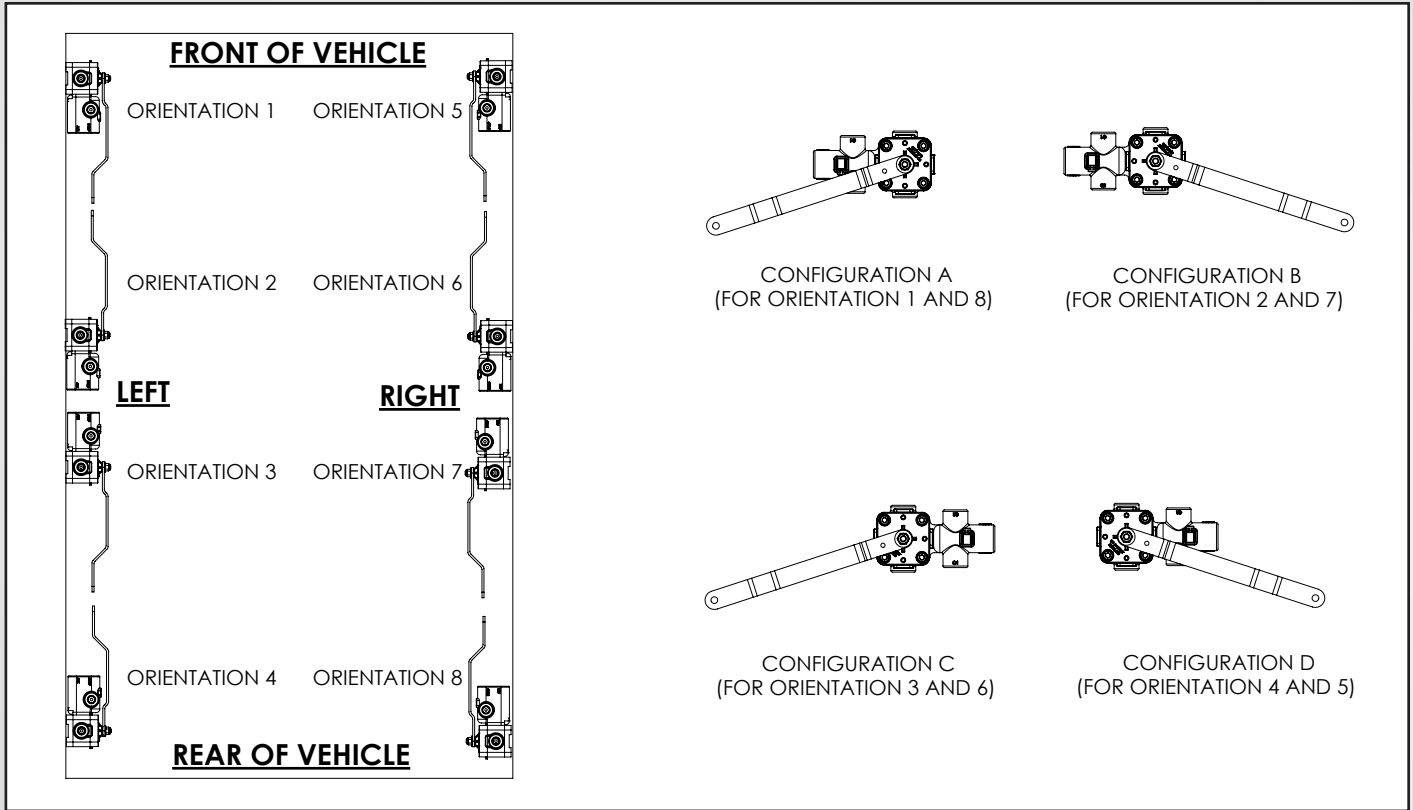

**NOTE:** Please select the configuration for your Atlas valve based on the orientation the valve will be mounted.

## Atlas Valve Mode Functions

Solution	Primary Function	Secondary Mode
1	First Ride Height & Dump (Quick Exhaust)	Raise
2		Lower
3		Blocking
4		Variable Flow
5	First Ride Height & Reverse Dump (Quick Exhaust)	Raise
6		Lower
7		Blocking
8		Variable Flow
9	First Ride Height & Blocking (Air Retention)	Raise
10		Lower
11		Variable Flow
12	First Ride Height & Reverse Blocking (Air Retention)	Raise
13		Lower
14		Variable Flow

This table shows the multiple solutions Atlas can offer with various combinations of features.

## Technical Drawings

**NOTE A:**  
VALVE ARM LENGTH, POSITION, ORIENTATION AND LINKAGE ATTACHMENT HOLE SIZE CAN BE DESIGNED FOR MOST OEM APPLICATIONS

**NOTE B:**  
MOUNTING STUD LENGTH AND LOCATION CAN BE SPECIFIED FOR SPECIFIC OEM APPLICATIONS

**NOTE C:**  
SECOND RIDE CAN BE FACTORY SET TO EITHER RAISE OR LOWER THE CHASSIS BASED ON OEM SUSPENSION CONFIGURATIONS

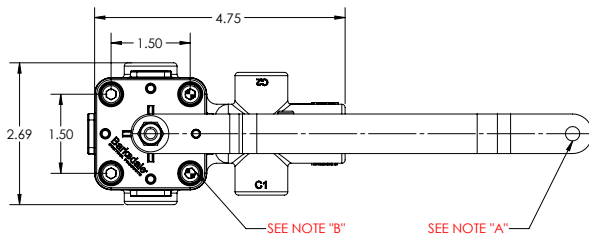
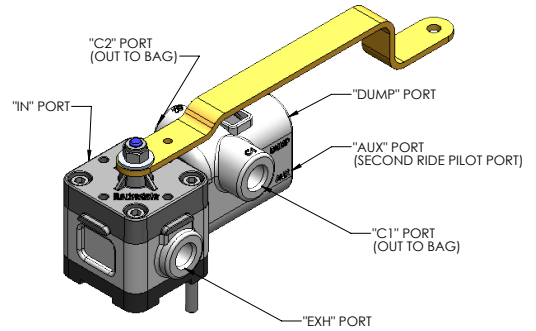

HANDLE POSITION IN FIRST(DEFAULT) RIDE HEIGHT

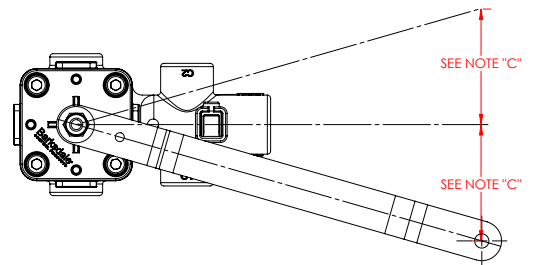

HANDLE POSITION IN SECOND RIDE HEIGHT

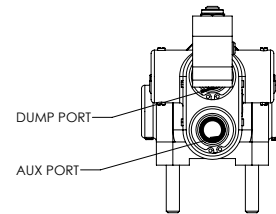
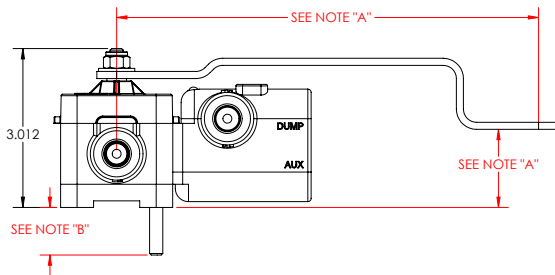

## Product Configurator

Example	52334	R	A
---------	-------	---	---

Series:

52334 Atlas Suspension Valve

Configuration:

A	Orientation 1 & 8
B	Orientation 2 & 7
C	Orientation 3 & 6
D	Orientation 4 & 5

Mode:

R	Raised Suspension
L	Lowered Suspension
B	Blocking Mode (Shut-off)
V	Variable Flow - High/Low
RB <sup>1</sup>	Raised Suspension + Blocking Mode
LB <sup>1</sup>	Lower Suspension + Blocking Mode

Note:

1. No dump function with this mode.