

General information

PWS27320220127

MH MOUNTING KIT is an assembly accessory that is easy to assemble and ideal for weighing roller conveyors, platforms, hoppers and tanks. The height of MH MOUNTING KIT can be adjusted in order to obtain in a simple and immediate way the perfect flatness of the system, thanks also to the use of our Tester 1008. The MH MOUNTING KIT is made of passivated zinc steel and it includes the anti-tilting function. The MH MOUNTING KIT accessory is also available in AISI stainless steel version 304 or AISI 316 upon request. MH MOUNTING KIT is compatible with our load cells: 65023 (with capacity 125÷250 kg and 300÷2000 kg), 65083 (with capacity 300÷2000 kg and 3000÷5000 kg), SB (with capacity 75÷250 kg) and SBR (with capacity 300÷2000 kg and 3000÷5000 kg). Contact us to get further information about MH MOUNTING KIT.

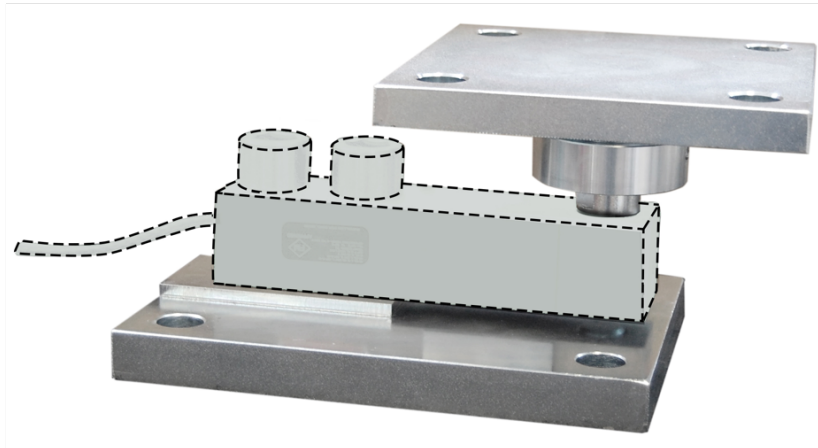

Suggested related products

A highly performing weighing system must be accurate, perfectly calibrated and well maintained. In order to improve the load cell performance and to optimize its functioning, you may need the following products:

Weight Transmitter [DAT 1400](#)

Mounting kits [MKX ®](#)

Tester 1008 [TESTER 1008](#)

Shear beam load cells [65023](#)

Junction Box [CGS4-C](#)

Shear beam load cells [SBR](#)

All indicated data may be changed without notice.
All the measures indicated are expressed in millimeters (mm).

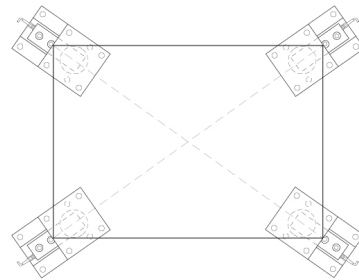
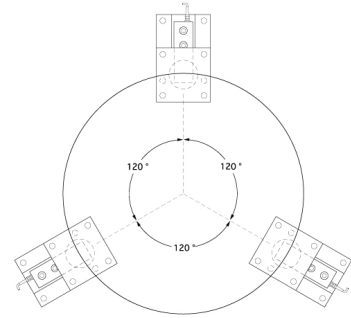
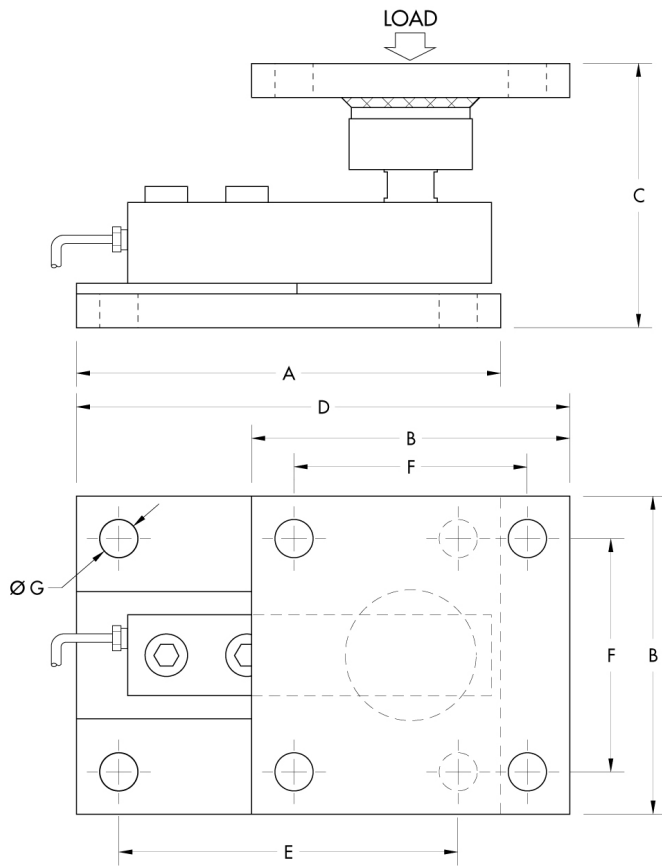
Mounting kits MH MOUNTING KIT

KIT	CAPACITY	A	B	C	D	E	F	G
MH1	75÷250	150	100	91÷94	181,6	120	70	13
MH2	300÷2000	150	100	98÷101	181,6	120	70	13
MH3	3000÷5000	200	150	120÷123	248,4	160	110	18
MH4	3000÷5000	200	150	130÷133	248,4	160	110	18

All indicated data may be changed without notice.
 All the measures indicated are expressed in millimeters (mm).