

General information

PWS16020220127

The CVS HT cell, made of steel, has been designed for the measurement of forces and works both in tension and compression. It has excellent linearity and accuracy and withstands overloads of over 300%. It has a watertight seal for use in severe environmental conditions, especially where there are high temperatures.



Suggested related products

A highly performing weighing system must be accurate, perfectly calibrated and well maintained. In order to improve the load cell performance and to optimize its functioning, you may need the following products:

High Temperature load cell [C2G1 HT](#)

Cable J.Boxes [CAVO HT](#)

High Temperature load cell [CMH HT](#)

High Temperature load cell [PSPRX HT](#)

High Temperature load cell [SB HT](#)

All indicated data may be changed without notice.
All the measures indicated are expressed in millimeters (mm).

Technical specifications

PWS16020220127

Rated load RL:	5, 10, 20, 30, 50, 100, 200, 300, 600, 1000 kN
Combined error:	±0.08 % RO
Repeatability:	±0.02 % RO
Creep (20 minutes):	±0.02 % RO
Safe overload:	150 % RL
Ultimate overload:	> 300 % RL
Material:	Stainless steel 17-4PH
Degree of protection:	IP67
Deflection:	0.35 mm
Compensated Temperature:	-10 ÷ +90 °C
Temperature range:	-20 ÷ +120 °C
Temperature effect on zero balance:	< ±0.005 % RO/°C
Temperature effect on output:	< ±0.005 % RO/°C
Rated output RO:	2.0 mV/V ±0.1 %
Zero balance:	< ±1.5 % RO
Insulation resistance:	> 5000 MOhm
Input resistance:	700 ±20 Ohm
Output resistance:	700 ±5 Ohm
Recommended input:	2 ÷ 15 Vdc/ac

All indicated data may be changed without notice.
All the measures indicated are expressed in millimeters (mm).

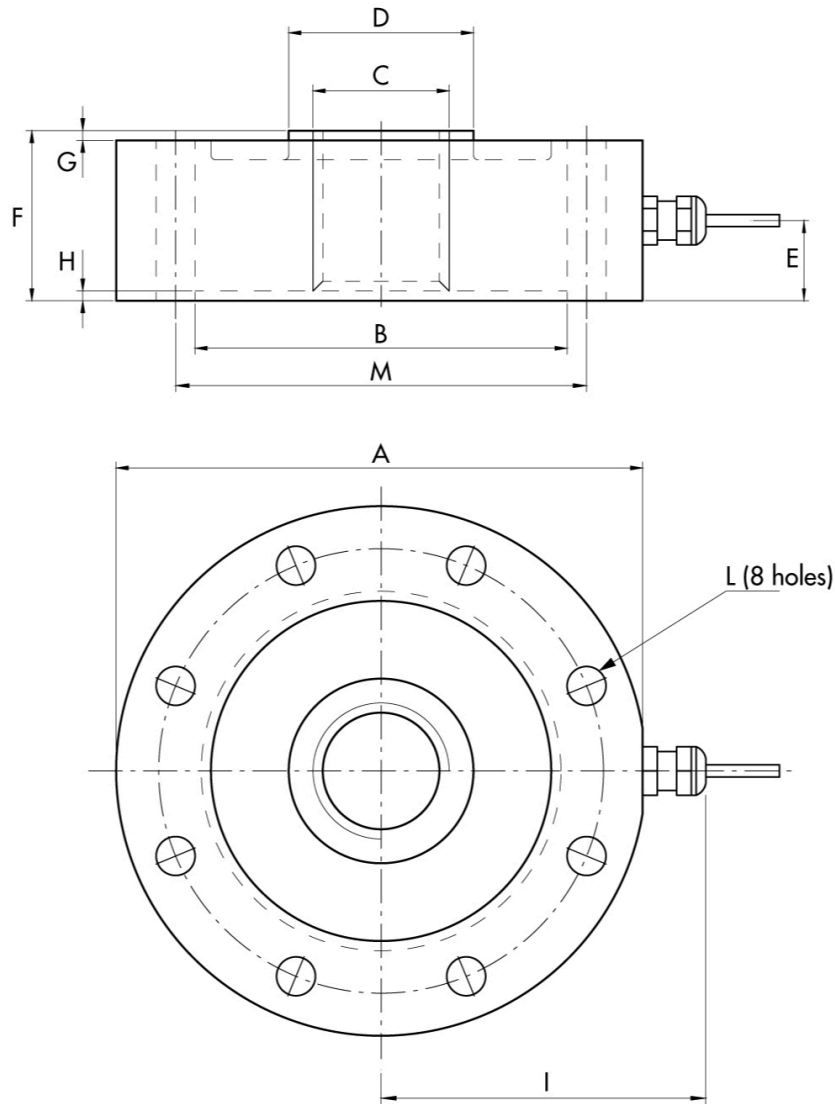

Capacity kN	ØA	ØB	ØC	ØD	E	F	G	H	I	ØL	M
5-30	99	72.2	M20x1.5	31	14	30	2	1.5	60	8.5	85
50-100	109	78.3	M24x2	38	15	35	2	1.5	65	8.5	94
200-600	164	113	M48x3	70	13.5	50	5	2	100	16.5	136
1000	219	135	M64x4	88	19	70	5	3	120	26	175

Electrical Connections	
+Excitation	Red
-Excitation	Black
+Sense	Blue
-Sense	Brown
+Signal	Green
-Signal	White
Shield	Cable shield

All indicated data may be changed without notice.
 All the measures indicated are expressed in millimeters (mm).