



## Vibration Monitoring Unit Series HE255

MADE IN GERMANY **SIL2** **PL-d**

**CE** **IECEE** **EAC**

**Ex** **IECEX** **EACEx**

**UL** **US**  
LISTED

Proc. Cont. Eq.  
for Ord. Loc.  
Proc. Cont. Eq.  
for Haz. Loc.

Segurança  
**INMETRO** **UL**  
BR  
OCP-0029



- Vibration acceleration (g rms)
- Bearing status parameter for roller bearing diagnostic
- ATEX / IECEx / EACEx Zone 2 / 22 and 1 / 21
- cULus OrdLoc / HazLoc Div 2
- 2 potential-free switching contacts (Window function)
- 2 analogue current outputs: 4–20 mA
- Frequency range: 10 Hz – 1000 Hz  
1 Hz – 1000 Hz

Date of manufacture: \_\_\_\_\_

Type description: \_\_\_\_\_

Serial no.: \_\_\_\_\_

## **Operating instructions**

### **Vibration Monitoring Unit Type HE255**

Standard and ATEX / IECEx / EACEx

**Version: 2021-08-25**

**Attention!**

Prior to commissioning the product, the instruction manual must be read and understood.

All rights reserved, including rights to translation.  
Subject to modifications.

Please contact the company with any questions:

HAUBER-Elektronik GmbH

Fabrikstraße 6

D-72622 Nürtingen

Germany

Tel.: +49 (0) 7022 / 21750-0

Fax: +49 (0) 7022 / 21750-50

info@hauber-elektronik.de

www.hauber-elektronik.de

---

# 1 Contents

1	Contents.....	3
2	Safety information .....	4
3	Scope of this instruction manual .....	5
4	Vibration monitoring HE255 .....	5
5	Intended Use.....	5
6	Scope of supply .....	5
7	Documents and Certificates.....	6
8	Transfer of liability when operating in potentially explosive atmospheres .....	6
9	Overview of application areas.....	7
10	Example labels.....	8
11	Information on the cULus validity range .....	9
12	Functional safety instructions .....	10
12.1	Safety level / key indicators .....	10
12.2	General notes .....	10
12.3	Instructions for the Fail Safe State.....	10
13	Technical data.....	11
13.1	General data .....	11
13.2	Electrical data .....	11
13.3	Typical frequency response.....	12
13.4	Mechanical data.....	13
13.5	Housing dimensions.....	13
14	Connections .....	15
15	Functional description .....	16
15.1	Operating conditions .....	16
15.2	Alarm and limit setting .....	17
15.3	Limit values and delay times.....	18
15.4	Bearing status parameter for roller bearing diagnostic.....	19
16	Assembly and disassembly.....	20
16.1	General notes .....	20
16.2	Fixing the vibration monitoring unit to the mounting surface .....	21
16.3	Tamper protection.....	21
17	Installation and commissioning .....	22
17.1	General notes .....	22
17.2	Earthing concept.....	22
18	Maintenance and repair .....	23
18.1	General notes .....	23
18.2	Troubleshooting Table .....	23
19	Transport, storage and disposal .....	23
20	Coding HE255.....	25
21	EU declaration of conformity.....	26

## 2 Safety information

### 2.1 General

*The safety instructions are intended to protect people and property from damage and hazards that could arise as the result of improper use, incorrect operation or other misuse or devices, especially in explosive areas. Therefore, please read the operating instructions carefully before working on the product or operating it. The operating instructions must be accessible to operating personnel at all times.*

Please make sure that all documents are present and complete before commissioning or performing other work on the product. If the documents have not all been delivered in full or if further copies are necessary, they can also be obtained in other languages.

The product is built according to the latest state of the art. However, hazards to people, machinery and systems can still arise as the result of improper handling, unintended use or operation and maintenance by persons inadequately trained on the product.

All those who are involved in the installation, operation and maintenance of the product in the operator's plant must read and understand the operating instructions.

The product may only be assembled, disassembled, installed and repaired by instructed, sufficiently trained and authorised personnel.

### 2.2 Symbols used



This symbol indicates an explosion hazard.



This symbol indicates a hazard from electrical current.



This symbol indicates safety-related information.



This symbol indicates information unrelated to safety.

### 3 Scope of this instruction manual

This instruction manual for the HE255-type vibration monitoring unit applies to the following versions:

HE255.00, HE255.01 and HE255.02

The variants are functionally identical. The variants HE255.01 and HE255.02 have additional certifications and labels which permit use in potentially exclusive atmospheres.

For further information, see chapter "Overview of application areas" on page 7.

### 4 Vibration monitoring HE255

The HE255 type vibration monitoring unit is used to measure and monitor the vibration acceleration of machinery. Furthermore, vibration monitoring determines a bearing status parameter for the roller bearing diagnostic. It offers the following features:

- Two limit values and associated delay timings can be adjusted separately.
- The two potential-free switching contacts will signal when values exceed or fall below the limit values of the defined window area. This can be used to generate an alarm.
- Measurement parameter: vibration acceleration (g rms).
- Analogue current output: Interference-free DC signal from 4-20 mA, proportional to the measuring range of the monitoring unit.
- Analogue current output: Interference-free DC signal from 4-20 mA, bearing status parameter
- A break on the monitoring cable can be detected by the subsequent evaluation device: DC signal value < 3.5 mA.

### 5 Intended Use

The HE255 is used to protect machines and mechanical equipment against undue strong vibrations. It may only be used in accordance with the specifications listed in the data sheet. It is used exclusively for measuring mechanical vibrations.

Main fields of application: Conveyors, screening equipment, drying and cooling equipment and similar oscillating mechanical equipment.



If the equipment is used in a manner not specified by the manufacturer, the protection provided by the equipment may be impaired.

### 6 Scope of supply

All versions include:

- Vibration monitoring
- Cylinder head screw with hex socket, M8 x 20 mm
- Seal label
- Operating instructions

## **7 Documents and Certificates**

You can find the following documents and certificates for HE255 type at [www.hauber-elektronik.de](http://www.hauber-elektronik.de) where they can be viewed and downloaded:

- EU type examination certificate ATEX, no.: UL 20 ATEX 2421 X Rev. 0
- Type examination certificate ATEX, no.: UL 21 ATEX 2570 X
- IECEx Certificate of conformity, no.: IECEx ULD 20.0022X
- UL Certificate of compliance, no.: E507077-20210204
- EACEx certificate, No.: %PLACEHOLDER%
- EAC Declaration
- Functional safety certificate (SIL 2)
- Safety manual SIL2







## **8 Transfer of liability when operating in potentially explosive atmospheres**

The owner of the system is exclusively liable for the appropriate configuration of the electrical connections with respect to explosion protection regulations and correct commissioning.

If the system is installed by a sub-contractor on behalf of the owner, the system may only be commissioned after the sub-contractor has issued written confirmation in the form of a certificate of installation that the system has been installed correctly and professionally in accordance with the applicable legal regulations.

The operator is obliged to notify the responsible authorities of the initial commissioning of explosion-protected systems or system components and their re-commissioning following extensive changes or maintenance.

9 Overview of application areas

Version		1	2	3	4	5	6	
Coding		HE255.00.xx.xx.xx.00.xxx	HE255.00.xx.xx.xx.01.xxx	HE255.02.xx.xx.xx.00.xxx	HE255.02.xx.xx.xx.01.xxx	HE255.01.xx.xx.xx.00.xxx	HE255.01.xx.xx.xx.02.xxx	
Connection	M12 connector	x		x				
	Integrated cable		x		x	x	x	
Measuring head temperature T <sub>M</sub> Ambient temperature T <sub>A</sub>	-40 °C ≤ T <sub>M</sub> ≤ 85 °C -40 °C ≤ T <sub>A</sub> ≤ 60 °C	x		x		x		
	Limitation for application area cULus: -30 °C ≤ T <sub>M</sub> ≤ 80 °C -30 °C ≤ T <sub>A</sub> ≤ 60 °C		x		x		x	
<b>CE IEC EAC</b>		x	x	x	x	x	x	
 Proc. Cont. Eq. Ord. Loc	E507077	x	x	x	x			
Ex Zone 2 and 22	 II 3G Ex ec IIC T4 Gc II 3D Ex tc IIIC 135°C Dc			x	x			
	<b>IECEX</b> Ex ec IIC T4 Gc Ex tc IIIC 135°C Dc			x	x			
	 Proc. Cont. Eq. Haz. Loc. Class I, Division 2, Groups A, B, C and D, T4 Class II, Division 2 Groups F and G, T4	E516625			x	x		
	<b>EACEx</b> ?	?			x	x		
	 Ex ec IIC T4 Gc Ex tc IIIC 135°C Dc	UL-BR 21.1250X			x	x		
	<b>CCC</b> Ex nA IIC T4 Gc Ex tD A22 IP66/67 T135°C	No: 2021122315114599			x	x		
Ex Zone 1 and 21	 II 2G Ex db IIC T4 Gb II 2D Ex tb IIIC 135°C Db					x	x	
	<b>IECEX</b> Ex db IIC T4 Gb Ex tb IIIC 135°C Db					x	x	
	<b>EACEx</b> ?	?				x	x	
	 Ex db IIC T4 Gb Ex tb IIIC 135°C Db	UL-BR 21.1250X					x	x
	<b>CCC</b> Ex d IIC T4 Gb Ex tD A21 IP66/67 T135°C	No: 2021122315114599					x	x

10 Example labels

Variant 1 - HE255.00.xx.xx.xx.00.000

 Type: HE2xx.00.xx.xx.xx.00.000 Item-no.: 12345 Serial-no.: 123456 Measuring range $V_{Er}$ : 0...xx mm/s Frequency range $V_{Er}$ : xx...xxxx Hz	MADE IN GERMANY	IEC	 LISTED E507077 Proc. Cont. Eq. Ord. Loc.	EAC	Manufacturer: (производитель) Hauber-Elektronik GmbH Fabrikstraße 6 72622 Nürtingen Germany (Германия) www.hauber-elektronik.de
	 SIL2 PL-d	 -40 °C ≤ T <sub>Amb</sub> ≤ +60°C	 LISTED E507077 Proc. Cont. Eq. Ord. Loc.	 LISTED E507077 Proc. Cont. Eq. Ord. Loc.	
	 LISTED E516625	 LISTED E516625	 LISTED E516625	 LISTED E516625	
	 LISTED E516625	 LISTED E516625	 LISTED E516625	 LISTED E516625	

Variant 2 - HE255.00.xx.xx.xx.01.xxx

 Type: HE2xx.00.xx.xx.xx.01.xxx Item-no.: 12345 Serial-no.: 123456 Measuring range $V_{Er}$ : 0...xx mm/s Frequency range $V_{Er}$ : xx...xxxx Hz	MADE IN GERMANY	IEC	 LISTED E507077 Proc. Cont. Eq. Ord. Loc.	EAC	Manufacturer: (производитель) Hauber-Elektronik GmbH Fabrikstraße 6 72622 Nürtingen Germany (Германия) www.hauber-elektronik.de
	 SIL2 PL-d	 -35 °C ≤ T <sub>Amb</sub> ≤ +60°C	 LISTED E507077 Proc. Cont. Eq. Ord. Loc.	 LISTED E507077 Proc. Cont. Eq. Ord. Loc.	
	 LISTED E516625	 LISTED E516625	 LISTED E516625	 LISTED E516625	
	 LISTED E516625	 LISTED E516625	 LISTED E516625	 LISTED E516625	

Variant 3 - HE255.02.xx.xx.xx.00.000

 Type: HE2xx.02.xx.xx.xx.00.000 Item-no.: 12345 Serial-no.: 123456 Measuring range $V_{Er}$ : 0...xx mm/s Frequency range $V_{Er}$ : xx...xxxx Hz	MADE IN GERMANY	IECEx	 LISTED E516625	II 3G Ex ec IIC T4 Gc II 3D Ex to IIIC T135°C Dc UL 21 ATEX 2570X IECEx ULD 20.0022X UL-BR 21.1250X	%Ex % % % % Ex % % % T % % °C % № xx / xx/xxxx	Manufacturer: (производитель) Hauber-Elektronik GmbH Fabrikstraße 6 72622 Nürtingen Germany (Германия) www.hauber-elektronik.de
	 SIL2 PL-d	 -40 °C ≤ T <sub>Amb</sub> ≤ +60°C	 LISTED E516625	 LISTED E516625	%Ex % % % % Ex % % % T % % °C % № xx / xx/xxxx	
	 LISTED E516625	 LISTED E516625	 LISTED E516625	 LISTED E516625	%Ex % % % % Ex % % % T % % °C % № xx / xx/xxxx	
	 LISTED E516625	 LISTED E516625	 LISTED E516625	 LISTED E516625	%Ex % % % % Ex % % % T % % °C % № xx / xx/xxxx	

Variant 4 - HE255.02.xx.xx.xx.01.xxx

 Type: HE2xx.02.xx.xx.xx.01.xxx Item-no.: 12345 Serial-no.: 123456 Measuring range $V_{Er}$ : 0...xx mm/s Frequency range $V_{Er}$ : xx...xxxx Hz	MADE IN GERMANY	IECEx	 LISTED E516625	II 3G Ex ec IIC T4 Gc II 3D Ex to IIIC T135°C Dc UL 21 ATEX 2570X IECEx ULD 20.0022X UL-BR 21.1250X	%Ex % % % % Ex % % % T % % °C % № xx / xx/xxxx	Manufacturer: (производитель) Hauber-Elektronik GmbH Fabrikstraße 6 72622 Nürtingen Germany (Германия) www.hauber-elektronik.de
	 SIL2 PL-d	 -35 °C ≤ T <sub>Amb</sub> ≤ +60°C	 LISTED E516625	 LISTED E516625	%Ex % % % % Ex % % % T % % °C % № xx / xx/xxxx	
	 LISTED E516625	 LISTED E516625	 LISTED E516625	 LISTED E516625	%Ex % % % % Ex % % % T % % °C % № xx / xx/xxxx	
	 LISTED E516625	 LISTED E516625	 LISTED E516625	 LISTED E516625	%Ex % % % % Ex % % % T % % °C % № xx / xx/xxxx	

Variant 5 - HE255.01.xx.xx.xx.00.xxx

 Type: HE2xx.01.xx.xx.xx.00.xxx Item-no.: 12345 Serial-no.: 123456 Measuring range $V_{Er}$ : 0...xx mm/s Frequency range $V_{Er}$ : xx...xxxx Hz	MADE IN GERMANY	IECEx	 LISTED E516625	II 2G Ex db IIC T4 Gb II 2D Ex tb IIIC T135°C Db UL 20 ATEX 2421X IECEx ULD 20.0022X UL-BR 21.1250X	%Ex % % % % Ex % % % T % % °C % № xx / xx/xxxx	Manufacturer: (производитель) Hauber-Elektronik GmbH Fabrikstraße 6 72622 Nürtingen Germany (Германия) www.hauber-elektronik.de
	 SIL2 PL-d	 -40 °C ≤ T <sub>Amb</sub> ≤ +60°C	 LISTED E516625	 LISTED E516625	%Ex % % % % Ex % % % T % % °C % № xx / xx/xxxx	
	 LISTED E516625	 LISTED E516625	 LISTED E516625	 LISTED E516625	%Ex % % % % Ex % % % T % % °C % № xx / xx/xxxx	
	 LISTED E516625	 LISTED E516625	 LISTED E516625	 LISTED E516625	%Ex % % % % Ex % % % T % % °C % № xx / xx/xxxx	

Variant 6 - HE255.01.xx.xx.xx.02.xxx

 Type: HE2xx.01.xx.xx.xx.02.xxx Item-no.: 12345 Serial-no.: 123456 Measuring range $V_{Er}$ : 0...xx mm/s Frequency range $V_{Er}$ : xx...xxxx Hz	MADE IN GERMANY	IECEx	 LISTED E516625	II 2G Ex db IIC T4 Gb II 2D Ex tb IIIC T135°C Db UL 20 ATEX 2421X IECEx ULD 20.0022X UL-BR 21.1250X	%Ex % % % % Ex % % % T % % °C % № xx / xx/xxxx	Manufacturer: (производитель) Hauber-Elektronik GmbH Fabrikstraße 6 72622 Nürtingen Germany (Германия) www.hauber-elektronik.de
	 SIL2 PL-d	 -20 °C ≤ T <sub>Amb</sub> ≤ +60°C	 LISTED E516625	 LISTED E516625	%Ex % % % % Ex % % % T % % °C % № xx / xx/xxxx	
	 LISTED E516625	 LISTED E516625	 LISTED E516625	 LISTED E516625	%Ex % % % % Ex % % % T % % °C % № xx / xx/xxxx	
	 LISTED E516625	 LISTED E516625	 LISTED E516625	 LISTED E516625	%Ex % % % % Ex % % % T % % °C % № xx / xx/xxxx	



## 11 Information on the cULus validity range

In order to install the device according to the UL/CSA/IEC standard, the following information must be observed.

### Electrical protection



Devices must be protected by means of fuses, circuit breakers, overheating protection, impedance-limiting switches or similar to ensure protection against excessive power output if there is a fault in the device. Protection must be applied to supply lines and switching lines.



A circuit breaker suitable for 30V/3A according to UL Standard 489/CSA Standard (C22.2) no. 5/IEC 60947-2 must be installed near the device.



A fuse suitable according to UL Standard 248/CSA Standard (C22.2) no. 248/IEC 60127 must be installed near the device. The fuse must have a slow triggering characteristic ("T").

### Limited temperature range

The following temperature ranges apply for variants with integrated cable:

Measuring head temperature	$-30\text{ °C} \leq T_M \leq +80\text{ °C}$
Ambient temperature	$-30\text{ °C} \leq T_{Amb} \leq +60\text{ °C}$

## 12 Functional safety instructions

### 12.1 Safety level / key indicators

The HE255 vibration monitoring hardware was tested by TÜV Süd. The results meet the criteria according to SIL2 and PI-d.

MTTF	984898h = 112,43 years
DC <sub>avg</sub>	>90% Diagnostic Coverage
MTTF <sub>d</sub>	2889526h = 329,85 years = <b>LOW</b>
CCF	100 (fulfilled)

Further safety metrics and information can be found in the safety manual.

### 12.2 General notes



A reboot of the vibration monitoring unit must be performed annually in order to test the switching of potential-free switching contacts.

### 12.3 Instructions for the Fail Safe State

When the power supply is switched on, the vibration monitoring unit will perform a self-test. During operation, self-tests are performed automatically in cycles. If a self-test fails, the vibration monitoring unit switches to the Fail Safe State. In the Fail Safe State all status LEDs are lit, all potential-free switching contacts are open and the analogue current output supplies 0 mA.

### 13 Technical data

#### 13.1 General data



Each sensor has one of the listed measuring and frequency ranges. Further ranges on request.

Please indicate the measuring and frequency range in your request.

Measuring range:	0 – 1 g rms 0 – 2 g rms 0 – 4 g rms 0 – 6 g rms 0 – 8 g rms 0 –10 g rms
Measuring accuracy:	± 10% (as per DIN ISO 2954)
Transverse sensitivity:	< 5%
Frequency range:	10 Hz–1,000 Hz (standard) 1 Hz–1000 Hz
Calibration point:	159.2 Hz and 90% amplitude of measuring range
Ready delay:	10 sec seconds
Bearing status parameter:	Weighted crest factor. Crest factor $k_s = \frac{ X _{max}}{X_{eff}}$ Weight / categorised by vibration intensity diagram from DIN ISO 13373-3
Maximum acceleration:	±16.5 g
Lifetime:	10 years

Tab. 1: General data

#### 13.2 Electrical data

Output signal:	1 x 4-20 mA (proportional to the measuring range) 1 x 4-20 mA (bearing status parameter)
Switching contact:	2 x potential-free switching contacts (pre- and main alarm)
Switching contact switching load:	1A / 30 V DC
Power supply:	24 V DC ± 10%
Power input (max.):	100 mA
Load/output load (max.):	500 Ω
Automatic:	As soon as the vibration values fall below the limit values, the potential-free switching contacts <b>automatically</b> re-energize.

Tab. 2: Electrical data

**13.3 Typical frequency response**

**10 Hz–1,000 Hz (standard)**

The frequency response is recorded using a reference sensor.

- 4 Hz. . . 1200 Hz acceleration sensor

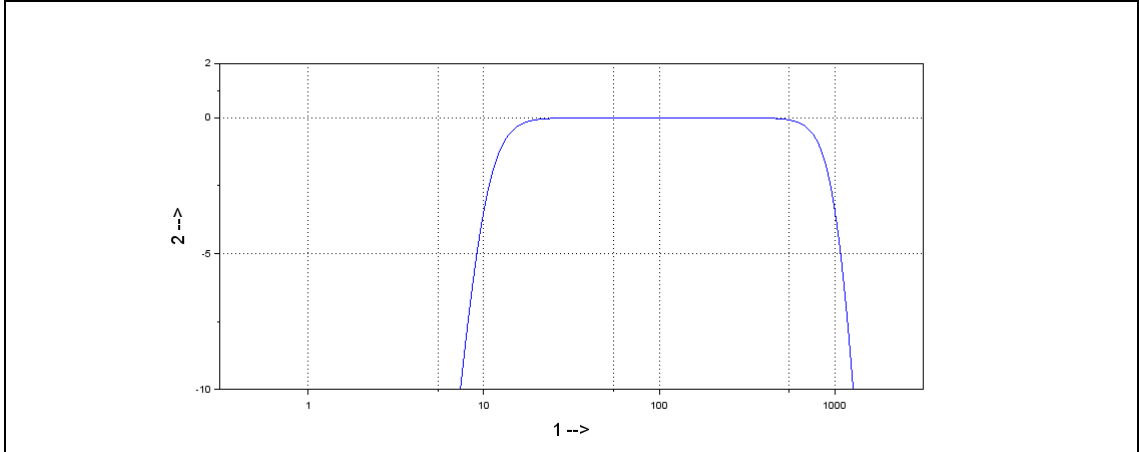

*Fig. 1: Typical frequency response 10 Hz–1000 Hz*

- 1 Frequency in Hz
- 2 Amplification in dB

**1 Hz–1000 Hz**

The frequency response is recorded using two reference sensors.

- 1 Hz. . . 10 Hz laser sensor
- 10 Hz. . . 1200 Hz acceleration sensor

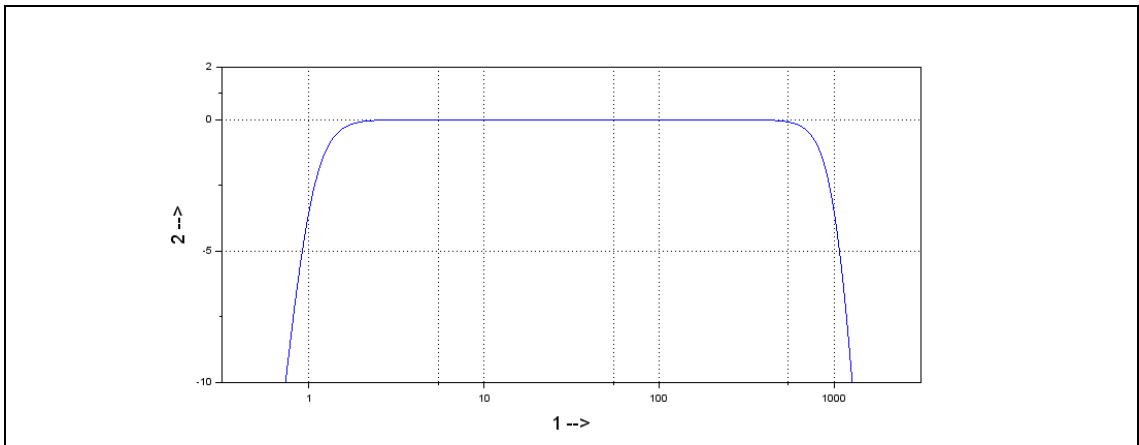

*Fig. 2: Typical frequency response 1 Hz–1000 Hz*

- 1 Frequency in Hz
- 2 Amplification in dB

13.4 Mechanical data



For more information see Section "Coding" on page 25.

Housing material:	Stainless steel V2A, material no.: 1.4305 (standard)
Fastening:	Cylinder head Allen screw M8 x 20 mm Thread pitch: 1.25 mm (standard)
Mounting:	Housing must be earthed via the M8 fastening
Cover tightening torque:	5 Nm
Measuring direction:	Along the fastening axis
Weight:	approx. 500 g
Protection class:	Cover and plug connection closed: IP 66/67 Type 4X Enclosure Product is suitable for outdoor applications
Max. humidity:	100%

Tab. 3: Mechanical data

13.5 Housing dimensions

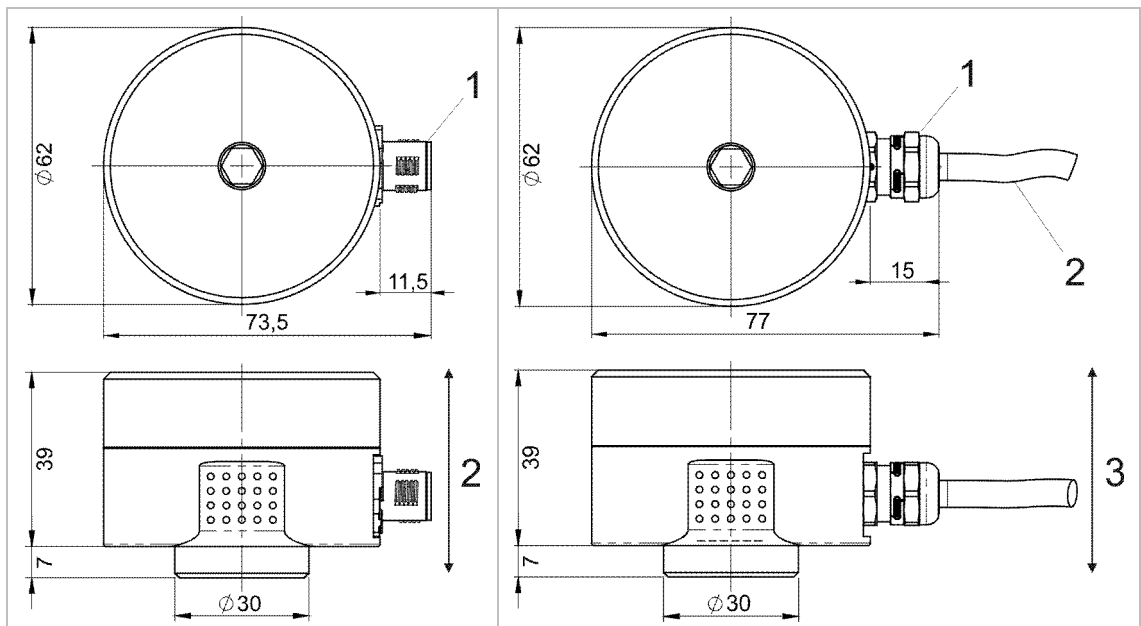

Fig. 3: Housing with M12 connector

Fig. 4: Housing with integrated cable

- 1 M12 connector
- 2 Measuring direction

- 1 Cable gland
- 2 Connecting cable
- 3 Measuring direction

All measurements  
in mm

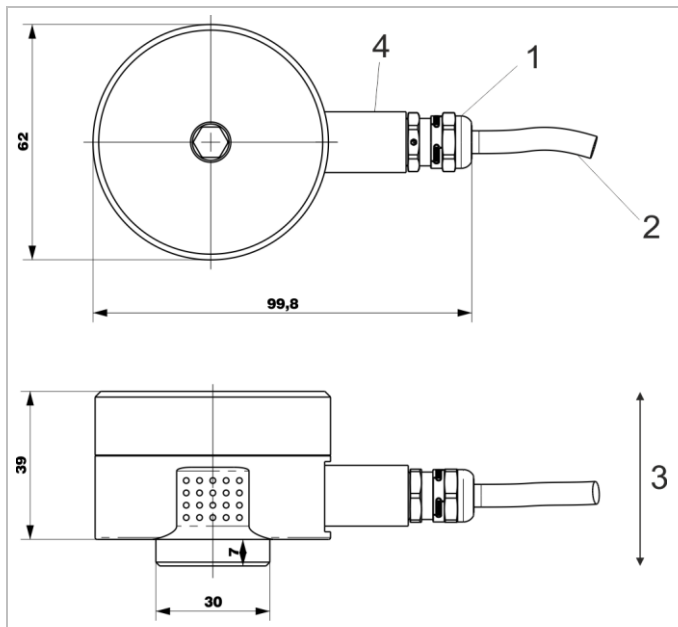

Fig. 5: Housing with integrated cable and clamp sleeve base for protective metal hose

- 1 Cable gland
- 2 Connecting cable
- 3 Measuring direction
- 4 Clamp sleeve base for protective metal hose

## 14 Connections

<b>Version:</b>	<b>M12 connector</b>		
		Pin 1:	24 V DC
		Pin 2:	GND
		Pin 3:	4-20 mA vibration amplitude
		Pin 4:	4-20 mA bearing status parameter
		Pin 5:	Potential-free switching contact 1 +
		Pin 6:	Potential-free switching contact 1 -
		Pin 7:	Potential-free switching contact 2 2 +
		Pin 8:	Potential-free switching contact 2 2 -
<b>Version:</b>	<b>Integrated cable</b>		
		Pin 1:	white 24 V DC
		Pin 2:	brown GND
		Pin 3:	green 4-20 mA vibration amplitude
		Pin 4:	yellow 4-20 mA bearing status parameter
		Pin 5:	grey Potential-free switching contact 1 +
		Pin 6:	pink Potential-free switching contact 1 -
		Pin 7:	blue Potential-free switching contact 2 2 +
		Pin 8:	red Potential-free switching contact 2 2 -
<b>Wiring diagram:</b>			
			

Fig. 6: Wiring diagram

- 1 Potential-free switching contact 1 (Pin 5: + , Pin 6: -)
- 2 Potential-free switching contact 2 (Pin 7: + , Pin 8: -)
- 3 Evaluation unit vibration amplitude
- 4 Evaluation unit bearing status parameter

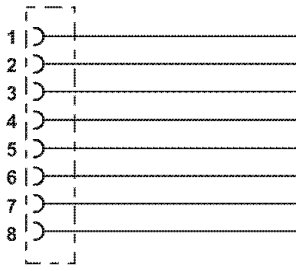
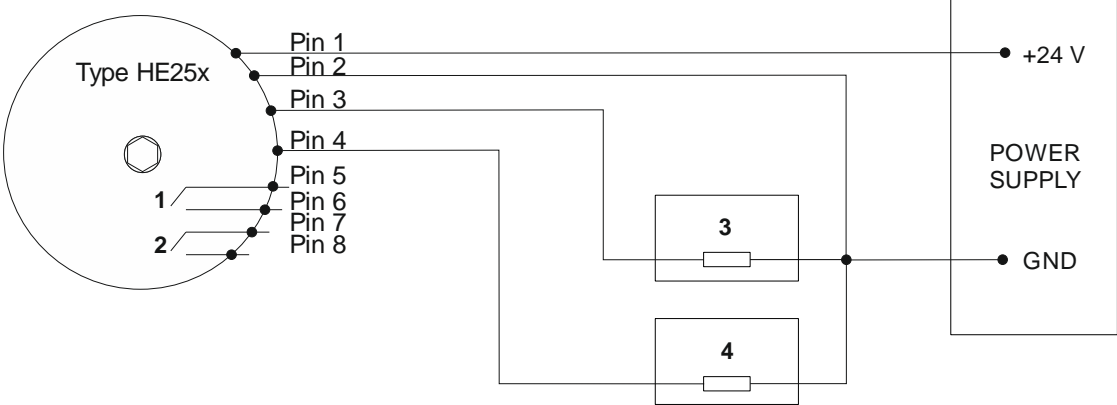

The wiring diagram shows the alarm status or the current status! Potential-free switching contacts 1 and 2 are open.

## 15 Functional description



In an explosive atmosphere the vibration monitoring unit HE255 will only be opened in a de-energized state.

The type HE255 is used for monitoring vibration acceleration. If the acceleration value is below or above the adjustable window area, an alarm will be triggered. The vibration monitoring contains two channels independent from each other, LIM1 and LIM2. The lower limit value of the window area is adjusted on LIM1 and the upper limit value is adjusted on LIM2 (see chart). The HE255 type also has an analogue current output. This supplies direct current of 4-20 mA proportional to the vibration amplitude.

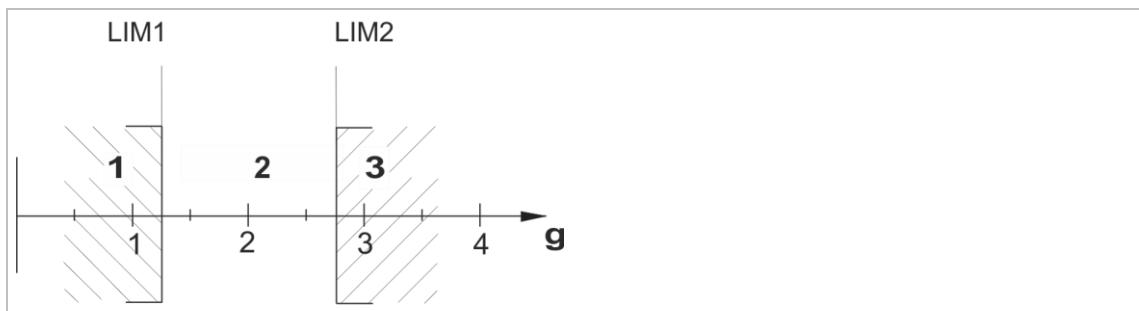

Fig. 7: Window function

- 1 Alarm for values below LIM1
- 2 Window area
- 3 Alarm for values above LIM2

### 15.1 Operating conditions

Operating state	Reading	Switching contacts	LED status
OK	Within limit values	Closed	green
WARNING	Outside of limit values, delay time runs	Closed	green + yellow
ALARM	Outside of limit values, delay time expired	Open	red
Fail Safe State	0 mA	Open	red + yellow + green
De-energized	0 mA	Open	All LEDs off

Tab. 4: Operating conditions



## **15.2 Alarm and limit setting**

By pressing the "Save Config" button, the current configuration is displayed by the LEDs around the HEX switches. For further information, see chapter "Limit values and delay times" on page 18.

The limit values and delay times are calibrated using the respective HEX switch. As soon as a switch position is changed, the LEDs around the Hex switch start to blink. The number of blinking LEDs represents the current position of the HEX switch. To save the configuration, press and hold down the "Save Config" button for three seconds. Acceptance of the configuration is signalled by steady lighting up of the LEDs in the selected HEX switch position.

After about five minutes the LEDs turn off automatically.

15.3 Limit values and delay times

SET Position ↓	Limit values (g)					
Measuring range →	0-1 g	0-2 g	0-4 g	0-6 g	0-8 g	0-10 g
0	0	0	0	0	0	0
1	0.063	0.125	0.25	0.375	0.5	0.625
2	0.125	0.25	0.5	0.75	1	1.25
3	0.188	0.375	0.75	1.125	1.5	1.875
4	0.25	0.5	1	1.5	2	2.5
5	0.313	0.625	1.25	1.875	2.5	3.125
6	0.375	0.75	1.5	2.25	3	3.75
7	0.438	0.875	1.75	2.625	3.5	4.375
8	0.5	1	2	3	4	5
9	0.563	1.125	2.25	3.375	4.5	5.625
10	0.625	1.25	2.5	3.75	5	6.25
11	0.688	1.375	2.75	4.125	5.5	6.875
12	0.75	1.5	3	4.5	6	7.5
13	0.813	1.625	3.25	4.875	6.5	8.125
14	0.875	1.75	3.5	5.25	7	8.75
15	0.938	1.875	3.75	5.625	7.5	9.375

Tab. 5: Limit values

The **SET rotary button** has 16 positions, representing the limit value of an alarm. The measuring range of the vibration monitoring unit is divided into 16 linear steps.

$$\text{In general: } \text{limit value} = \frac{\text{upper limit measuring range}}{16} \times \text{SET position}$$

**Example:** Limit setting

Measuring range: 0–4 g  
 SET rotary button Pos.: 8 (9)  
 Limit value: 2 g (2.25 g)

**Delay times**

TIME Position	0	1	2	3	4	5	6	7	8	9	10	11	12	13	14	15
Delay time (secs)	0	1	2	3	4	5	7.5	10	12.5	15	17.5	20	25	30	45	60

Tab. 6: Delay times

**15.4 Bearing status parameter for roller bearing diagnostic**

The monitoring of the HE255 has a bearing status parameter identification for the roller bearing diagnostic in accordance with DIN ISO 13373-3.

In accordance with DIN ISO 13373-3, the bearing status parameter observes the ratio of the highest peak acceleration value in  $m/s^2$  to the effective acceleration value in  $m/s^2$  rms. An averaging time of  $t=1s$  is established for the effective value of the bearing status parameter. The highest peak value is determined over the duration of the averaging time, meaning  $t=1s$  here as well.

The frequency range to be observed is between 10Hz–10kHz. The signal ratio serves to diagnose the bearing status for roller bearings, in line with the crest factor.

Norm DIN ISO 13373-3 categorises the roller bearing status into four ranges:

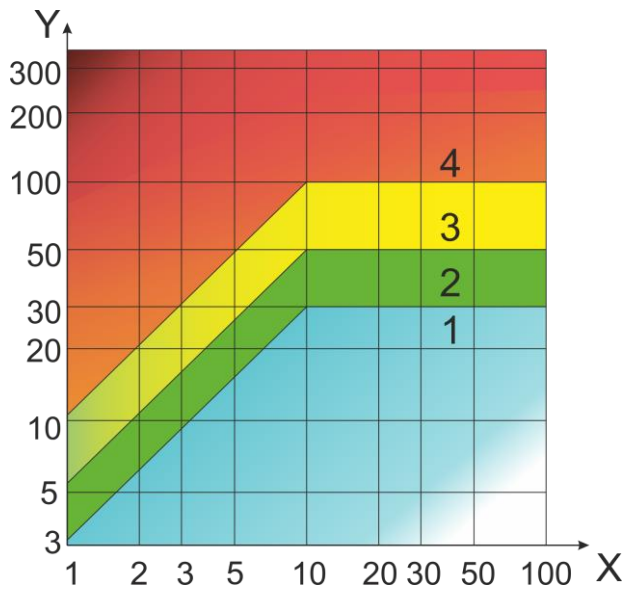

Fig. 8: Vibration intensity diagram [DIN ISO 13373-3]

- X Effective acceleration value (total value of 10 Hz to 10 kHz) in  $m/s^2$
- Y highest peak acceleration value in  $m/s^2$
- 1 range 1 = very low value
- 2 range 2 = normal (normal status)
- 3 range 3 = warning message
- 4 range 4 = alarm



This vibration intensity diagram is not recommended for machines powered by a gear unit or machines for which there is usually heavy background noise.

The vibration monitoring continually determines the bearing status parameter. The bearing status parameter is scaled based on the vibration intensity diagram at current output 4–20 mA.

Range	Meaning	Output signal $I_{LZK}$ in mA
Range 1	No bearing damage can be detected. The bearing status parameter is very low. It is recommended to repeat the measurement or change the installation location. If the bearing status parameter is still in range 1, this can be approved as the normal range after a check (e.g. frequency and time range analysis).	$4 \leq I_{LZK} < 8$
Range 2	The bearing status parameter is in the normal range. The parameter is in the typical normal status. There is no bearing damage.	$8 \leq I_{LZK} < 12$
Range 3	The bearing status parameter is in the warning range. It is recommended to check bearing by means of a frequency and time range analysis.	$12 \leq I_{LZK} < 16$
Range 4	The bearing status parameter is in the alarm range. It is recommended to consider changing the bearing.	$16 \leq I_{LZK} \leq 20$

Tab. 7: Meaning of ranges and their output signal

## 16 Assembly and disassembly

### 16.1 General notes

Assembly and disassembly work on and with the monitoring unit may only be performed by an authorised specialist familiar with the safety regulations governing handling electrical components! When using EX-certified monitoring units in potentially explosive atmospheres, the professional must also be familiar with the relevant safety regulations!



Before assembly and disassembly disconnect the monitoring unit from the power supply! Separate plug connections must always be de-energized! If EX-certified monitoring is operated in a potentially explosive atmosphere, there is otherwise an explosion hazard, due to spark formation!



The monitoring unit housing must be earthed via the fastening - through the machine earth of the mounting surface or through a separate protective conductor (PE)!

**16.2 Fixing the vibration monitoring unit to the mounting surface**

**Prerequisites**

- Mounting surface is clean and even; i.e. free of paint, rust, etc.
- Threaded hole in mounting surface: 15 mm, M8

**Tools and material**

- Hex socket key SW 6, SW 8
- Torque wrench SW 6, SW 8
- Cylinder head screw with hex socket M8x20
- Spring washers for M8

**Work steps and instructions**

- Unscrew housing cover from housing base; Allen key 8 mm
- Attach monitoring unit using cylinder head screws and spring washers with 8 Nm on mounting surface; Allen key 6 mm
- Screw the housing cover back onto the housing base and tighten to 5 Nm; Allen key 8 mm

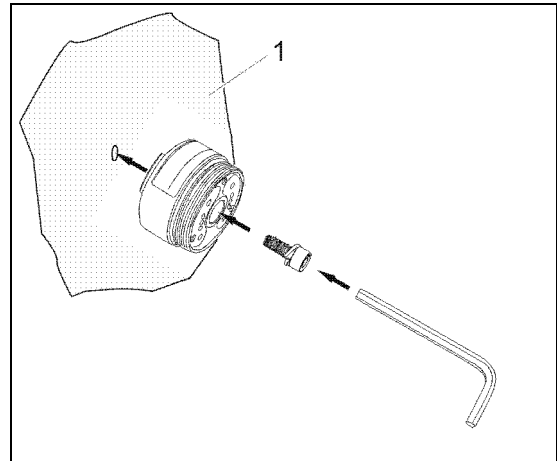

Fastening on mounting surface (1)

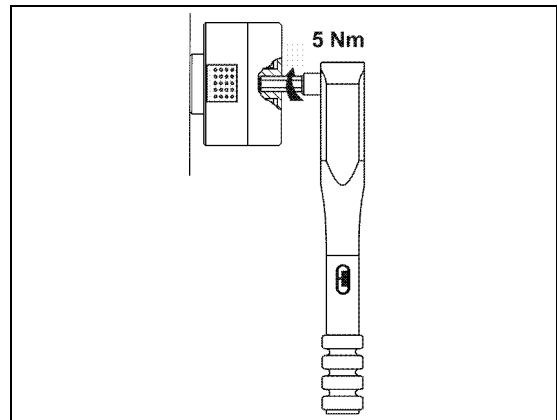

Tighten housing cover with torque wrench (2)



In order to avoid cold welding of the housing cover to the housing base, the thread is treated ex-works with an assembly paste for stainless steel connections.

**16.3 Tamper protection**

**Attach seal labels**

The "SEALED" seal label reveals any unauthorised opening of the housing cover.

After installation of the housing cover by the system operator, the seal label shall be attached to the side above the housing joint.

If any tampering is attempted, the seal label is destroyed and the tampering will be visible to the system operator

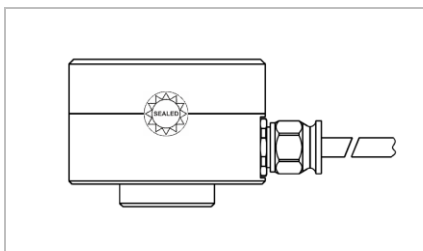

Fig. 9: Seal label

## 17 Installation and commissioning

### 17.1 General notes

Installation and commissioning of the vibration monitoring unit may only be performed by an authorised specialist familiar with the safety regulations governing handling electrical components. When installing and commissioning EX-certified monitoring units in potentially explosive atmospheres, the professional must also be familiar with the relevant safety regulations!



The commissioning will only be carried out with the housing cover correctly screwed on (tightening torque = 5 Nm)! If EX-certified monitoring is operated in a potentially explosive atmosphere, there is otherwise an explosion hazard, due to spark formation!



Protect the connection cable and any extension cable from electrical interference and mechanical damage! Local regulations and instructions must be observed in doing so!

### 17.2 Earthing concept

The earthing concept intends that the shielding of the cable is electrically connected to the housing of the sensor via the knurled nut and is at earth potential at the evaluation unit or at the control cabinet. In case of long cable lengths, it is recommended to disconnect the shield at the evaluation unit (4) to avoid compensating currents via the shield.

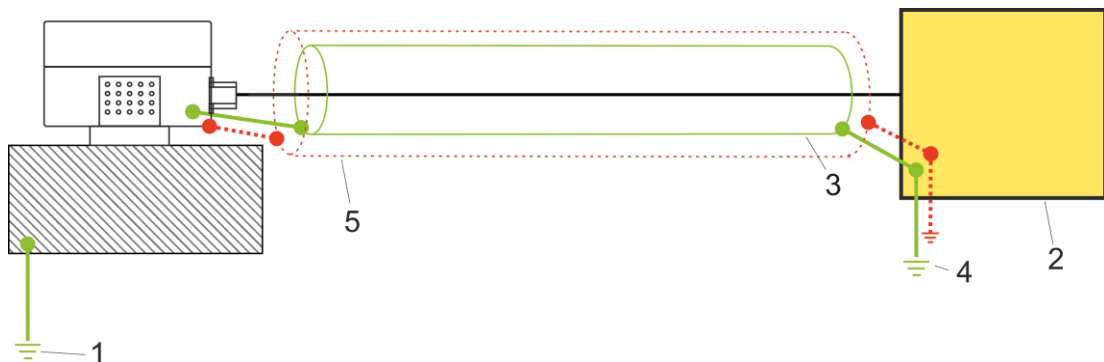

Fig. 10: Earthing concept HE255

- 1 Machine earth
- 2 Evaluation unit (measuring device, PLC, etc.)
- 3 Cable shielding
- 4 Earth potential evaluation unit
- 5 Optional protective metal hose (Only available for variants with an integrated cable)

## 18 Maintenance and repair

### 18.1 General notes



Repair and cleaning work on vibration monitoring units may only be performed by an authorised specialist familiar with the safety regulations governing handling electrical components.



Before repair and cleaning disconnect the monitoring unit from the power supply! Separate plug connections must always be de-energized!



Immediately replace defective connection cables!  
A defective vibration monitoring unit must be completely replaced!



The vibration monitoring unit HE255 is maintenance-free!

### 18.2 Troubleshooting Table

Fault	Cause	Action
No measured value (4-20 mA)	No power supply	Check power source and/or supply
	Discontinuity in connecting cable	Replace connecting cable
	Fuse defective	Replace fuse
	Connection has incorrect polarity	Connection of correct pole
	Vibration monitoring unit faulty	Replace Vibration Monitoring Unit
Switching contact doesn't switch	Wrong limit value set	Set correct limit value
	No power supply	Check power source and/or supply
	Discontinuity in connection	Replace connecting cable
	Fuse defective	Replace fuse
	Connection has incorrect polarity	Connection of correct pole
	Defective monitoring unit	Replace monitoring unit
Incorrect Reading	Vibration monitoring unit not mounted in a friction-locked manner	Mount vibration monitoring unit in a friction-locked manner
	Vibration monitoring unit installed in wrong place	Install vibration monitoring unit in correct place
	EMC problems	See "Earthing concept" on page 22.

Tab. 8: Troubleshooting Table

## 19 Transport, storage and disposal

The sensor must be protected from damaging environmental factors and mechanical damage during transport with the use of adequate packing.

The sensor may not be stored in ambient temperatures outside the permitted operating temperature.

The product contains electronic components and must be disposed of properly in accordance with local laws and regulations.



**20 Coding HE255**

HE255.	00.	2g.	01.	00.	00.	000
--------	-----	-----	-----	-----	-----	-----

**HE series**

255 = Monitoring SIL2  
 4-20 mA ~ g rms  
 free limit values (Window function)  
 4-20 mA bearing status parameter

**ATEX / IECEx / EACEx**

00 = no ATEX / IECEx / EACEx  
 01 = ATEX / IECEx / EACEx (Zone 1 / 21)  
 02 = ATEX / IECEx / EACEx (Zone 2 / 22)

**Measuring range**

1g = 1 g rms  
 2g = 2 g rms  
 4g = 4 g rms  
 6g = 6 g rms  
 8g = 8 g rms  
 10g = 10 g rms

**Frequency range**

00 = 10 – 1000 Hz (standard)  
 01 = 1 – 1000 Hz

**Housing material**

00 = 1.4305 (V2A) (standard)  
 01 = 1.4404 (V4A)  
 50 = 1.4305 (V2A) with adaptation for metal protection hose  
 51 = 1.4404 (V4A) with adaptation for metal protection hose

**Temperature range**

00 = -40°C to 85°C  
 01 = -35°C to 125°C  
 02 = -20°C to 125°C

**Connection**

000 = M12 connector (standard)  
 020 = 2 m integrated cable  
 050 = 5 m integrated cable  
 100 = 10 m integrated cable



Is your desired configuration not listed? Please contact us and we can offer you a solution for your specific needs.

## 21 EU declaration of conformity

### Declaration of conformity

HAUBER-Elektronik GmbH  
 Fabrikstraße 6  
 D-72622 Nürtingen

declares under its sole responsibility that the products listed below, to which this declaration refers, comply with the essential health and safety requirements of the directives and standards listed below.

### Product series

HE200, HE205, HE250, HE255

### ATEX Annex

UL International Demko A/S certifies as **Notified Body No. 0539** under the European Community Council Directive of February 26<sup>th</sup> 2014 (2014/34/EU) that the manufacturer maintains a production quality system that complies with **Annex IV** of this Directive.

### Directives and standards



EU-Directive	Standard
2014/30/EU	EN 61000-6-7:2015 EN 61000-6-3:2007 + A1:2011 EN55011:2016 + A1:2017
2014/34/EU	IEC 60079-0:2017 + Corr.1:2020 + I-SH01:2019 + I-SH02:2019 IEC 60079-1:2014 + Corr. 1:2018 + I-SH01:2020 IEC 60079-7:2017 IEC 60079-31:2013

### Affixed CE-Marking



 0539

### Marking and certificates

HE200.02 / HE205.02 / HE250.02 / HE255.02

Marking	Certificate
 II 3G Ex ec IIC T4 Gc  II 3D Ex tc IIIC 135°C Dc	UL 21 ATEX 2570 X

HE200.01 / HE205.01 / HE250.01 / HE255.01

Marking	Certificate
 II 2G Ex db IIC T4 Gb  II 2D Ex tb IIIC 135°C Db	UL 20 ATEX 2421 X Rev. 0

### Unterschrift

Nürtingen, den 03.05.2021

Place and date



Tobias Bronkal, managing proprietor